

Nontraditional Machining Processes

Dr.Ufaith H.Qadiri

Associate Professor

Mechanical Engineering

History of Material Development

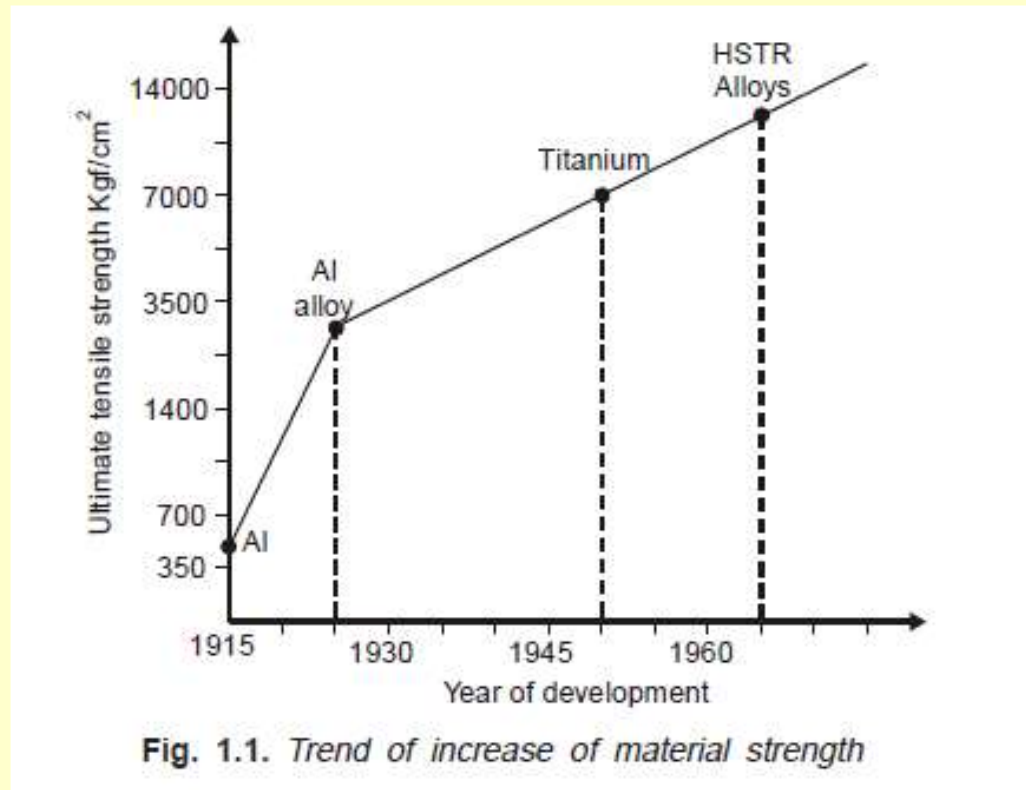

The requirements that lead to the development of nontraditional machining

- Very high hardness and strength of the material. (above 400 HB.)
- The work piece is too flexible or slender to support the cutting or grinding forces.
- The shape of the part is complex, such as internal and external profiles, or small diameter holes.
- Surface finish or tolerance better than those obtainable conventional process.
- Temperature rise or residual stress in the work piece are undesirable.

Conventional Machining VS NonConventional Machining

- The cutting tool and workpiece are always in physical contact, with a relative motion against each other, which results in friction and a significant *tool wear*.
- In non-traditional processes, there is no physical contact between the tool and workpiece. Although in some non-traditional processes tool wear exists, it rarely is a significant problem.
- Material removal rate of the traditional processes is limited by the mechanical properties of the work material. Non-traditional processes easily deal with such difficult-to-cut materials like ceramics and ceramic based tool materials, fiber reinforced materials, carbides, titanium-based alloys.

Continue . . .

- In traditional processes, the relative motion between the tool and work piece is typically rotary or reciprocating. Thus, the shape of the work surfaces is limited to circular or flat shapes. In spite of widely used CNC systems, machining of three-dimensional surfaces is still a difficult task. Most non-traditional processes were developed just to solve this problem.
- Machining of small cavities, slits, blind or through holes is difficult with traditional processes, whereas it is a simple work for some non-traditional processes.
- Traditional processes are well established, use relatively simple and inexpensive machinery and readily available cutting tools. Non-traditional processes require expensive equipment and tooling as well as skilled labor, which increases significantly the production cost.

Classification OF Processes

- Mechanical Metal removal Processes
- It is characterized by the fact that the material removal is due to the application of mechanical energy in the form of high frequency vibrations or kinetic energy of an abrasive jet.
- 1. Ultra sonic Machining (USM).
 2. Abrasive Jet Machining (AJM).
 3. Water Jet Machining (WJM).

Continue...

- **Electro-Chemical**
- It is based on electro-chemical dissolution of materials by an electrolyte under the influence of an externally applied electrical potential.
 1. Electro-Chemical Machining (ECM).
 2. ECG
 - 3 ECD

Continue...

- **Thermal Method**

The material is removed due to controlled, localized heating of the work piece. It result into material removal by melting and evaporation.

The source of heat generation in such cases can be widely different.

1. Electric Discharge Machining (EDM).
2. Plasma Arc Machining (PAM).
3. EBM 4. LBM

Abrasive Water-Jet Cutting

- A stream of fine grain abrasives mixed with air or suitable carrier gas, at high pressure, is directed by means of a nozzle on the work surface to be machined.
- The material removal is due to erosive action of a high pressure jet.
- AJM differ from the conventional sand blasting process in the way that the abrasive is much finer and effective control over the process parameters and cutting. Used mainly to cut hard and brittle materials, which are thin and sensitive to heat.

Abrasive Jet Machining Setup

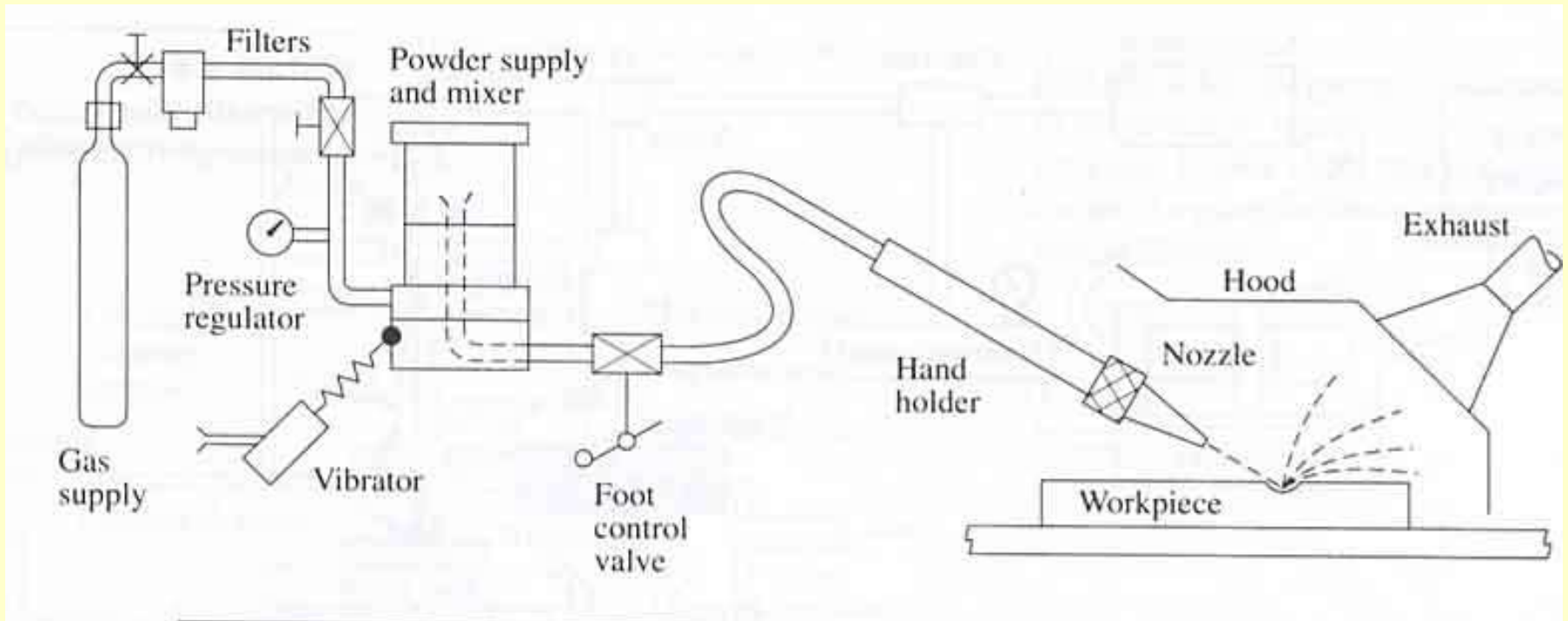

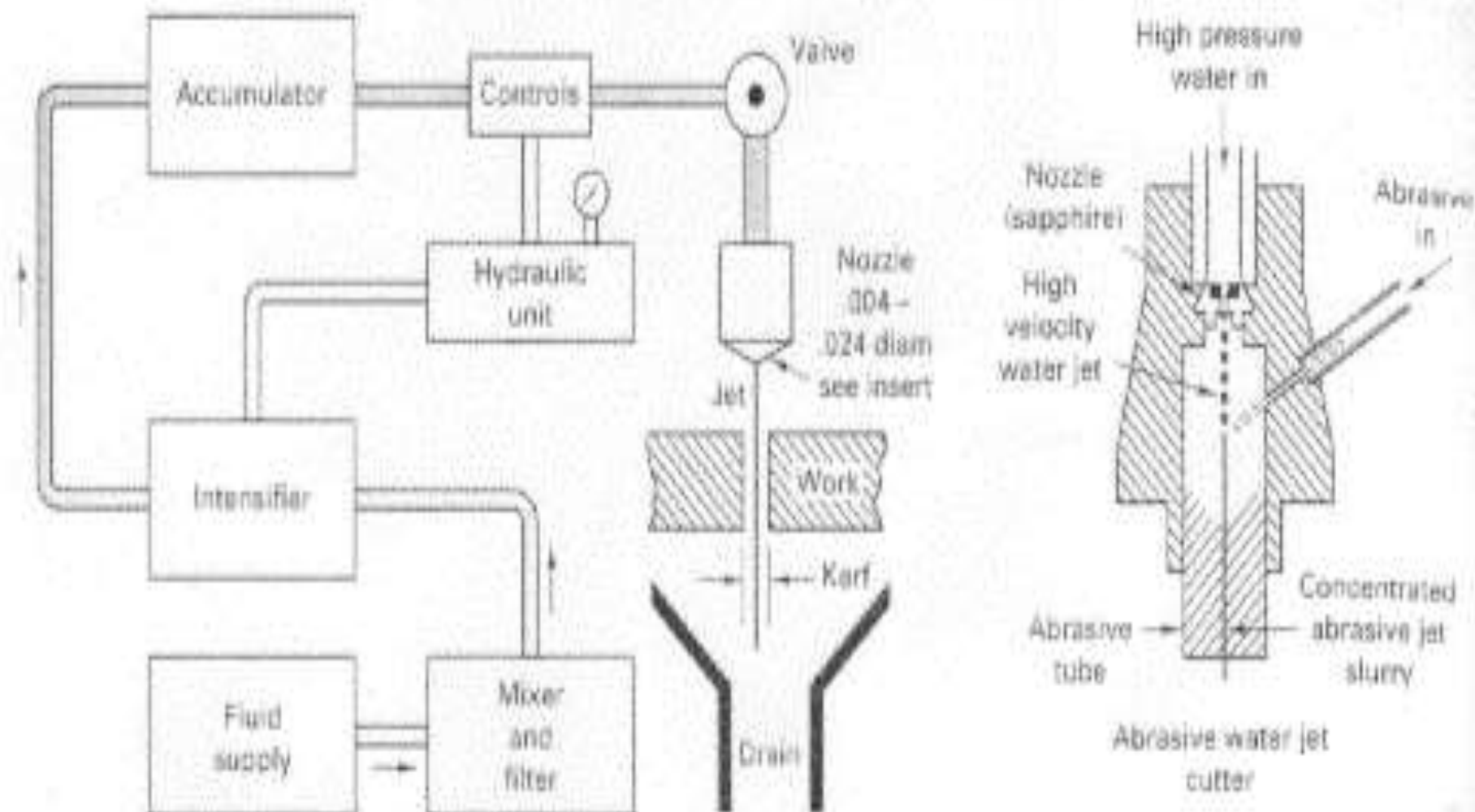

FIGURE 32-15 Schematic of hydrodynamic jet machining. The intensifier elevates the fluid to the desired nozzle pressure while the accumulator smooths out the pulses in the fluid jet. Schematic of an abrasive waterjet machining nozzle is shown on the right.

Typical AJM Parameters

- Abrasive
 - Aluminum oxide for Al and Brass.
 - SiC for Stainless steel and Ceramic\
 - Bicarbonate of soda for Teflon
 - Glass bed for polishing.
- Size
 - 10-15 Micron
- Quantity
 - 5-15 liter/min for fine work
 - 10-30 liter/min for usual cuts.
 - 50-100 liter/min for rough cuts.

Typical AJM Parameters

- Medium
 - Dry air, CO₂, N₂
 - Quantity: 30 liter/min
 - Velocity: 150-300 m/min
 - Pressure: 200-1300 KPa
- Nozzle
 - Material: Tungsten carbide or saffire
 - Stand of distance: 2.54-75 mm
 - Diameter: 0.13-1.2 mm
 - Operating Angle: 60° to vertical

Typical AJM Parameters

- Factors affecting MRR:
 - Types of abrasive and abrasive grain size
 - Flow rate
 - Stand off distance
 - Nozzle Pressure

- **Advantages of AJM**

- Low capital cost.
- Less vibration.
- Good for difficult to reach area.
- No heat is generated in work piece.
- Ability to cut intricate holes of any hardness and brittleness in the material.
- Ability to cut fragile, brittle hard and heat sensitive material without damage

- **Disadvantages of AJM:**

- Low metal removal rate.
- Due to stay cutting accuracy is affected.
- Particles are imbedded in work piece.
- Abrasive powder cannot be reused.

- **Applications of AJM:**

- For abrading and frosting glass, it is more economical than acid etching and grinding.
- For doing hard suffuses safe removal of smears and ceramics oxides on metals.
- Resistive coating etc from ports to delicate to withstand normal scrapping.
- Delicate cleaning such as removal of smudges from antique documents.
- Machining semiconductors such as germanium etc.

Water Jet Machining

- The water jet machining involves directing a high pressure (150-1000 MPa) high velocity (540-1400 m/s) water jet (faster than the speed of sound) to the surface to be machined. The fluid flow rate is typically from 0.5 to 2.5 l/min
- The kinetic energy of water jet after striking the work surface is reduced to zero.
- The bulk of kinetic energy of jet is converted into pressure energy.
- If the local pressure caused by the water jet exceeds the strength of the surface being machined, the material from the surface gets eroded and a cavity is thus formed.
- The water jet energy in this process is concentrated over a very small area, giving rise to high energy density (10^{10} w/mm²) High

Water Jet Machining Setup

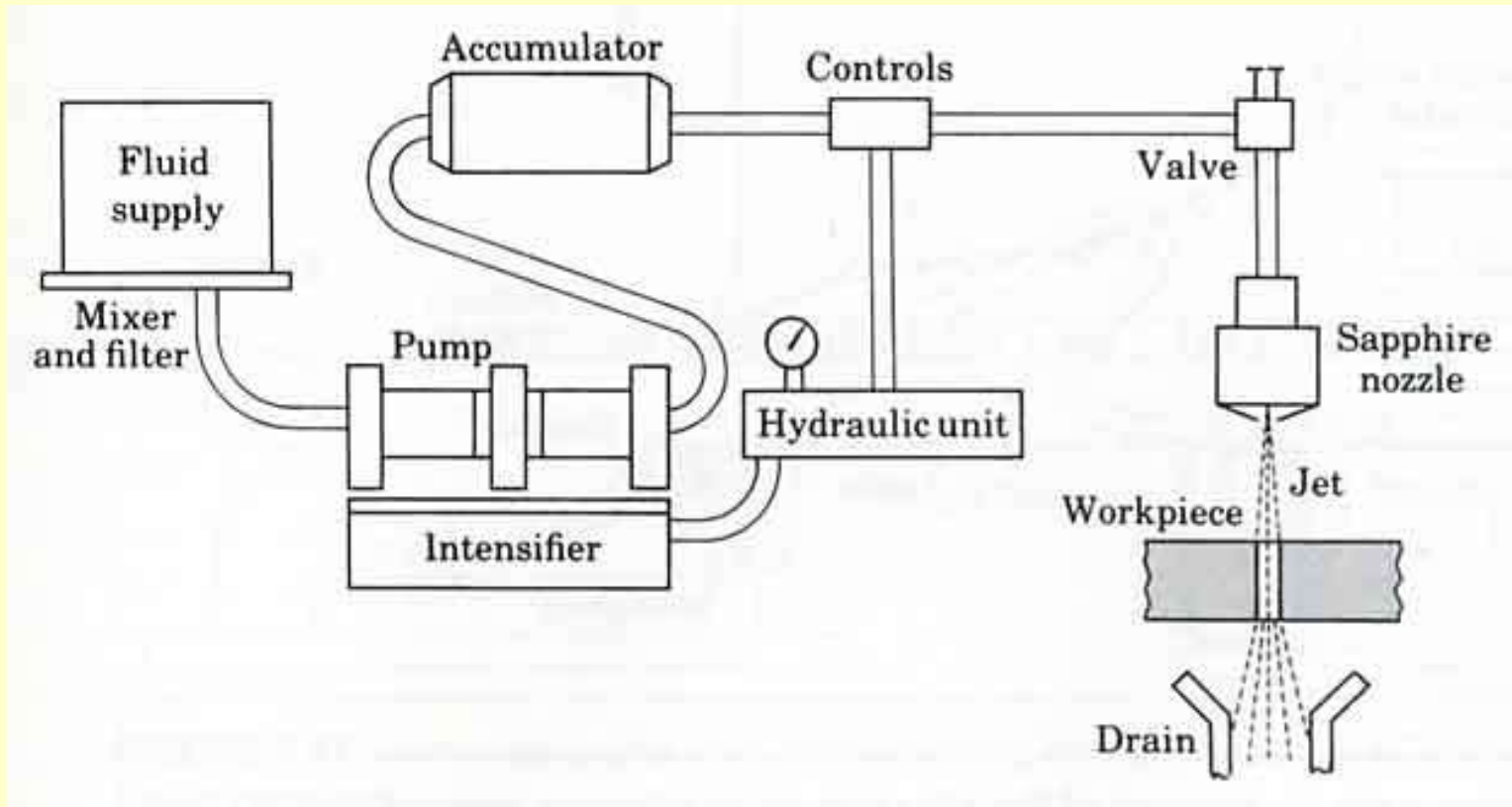

Continue...

- Water is the most common fluid used, but additives such as alcohols, oil products and glycerol are added when they can be dissolved in water to improve the fluid characteristics.
- Typical work materials involve soft metals, paper, cloth, wood, leather, rubber, plastics, and frozen food.
- If the work material is brittle it will fracture, if it is ductile, it will cut well:
- The orifice is often made of sapphire and its diameter ranges from 1.2 mm to 0.5 mm:

Water Jet Equipments

- It is consists of three main units
 - (i) A pump along with intensifier.
 - (ii)Cutting head comprising of nozzle and work table movement.
 - (iii) filter unit for debries,pout impurities.
- Advantages
 - no heat produced
 - cut can be started anywhere without the need for predrilled holes
 - burr produced is minimum
 - environmentally safe and friendly manufacturing.

Application – used for cutting composites, plastics, fabrics, rubber, wood products etc. Also used in food processing industry.

Abrasive Water jet machining

- The rate of cutting in water jet machining, particularly while cutting ductile material, is quite low. Cutting rate can be achieved by mixing abrasive powder in the water to be used for machining.
- In *Abrasive Water Jet Cutting*, a narrow, focused, water jet is mixed with abrasive particles.
- This jet is sprayed with very high pressures resulting in high velocities that cut through all materials.
- The presence of abrasive particles in the water jet reduces cutting forces and enables cutting of thick and hard materials (steel plates over 80-mm thick can be cut).
- The velocity of the stream is up to 90 m/s, about 2.5 times the speed of sound.

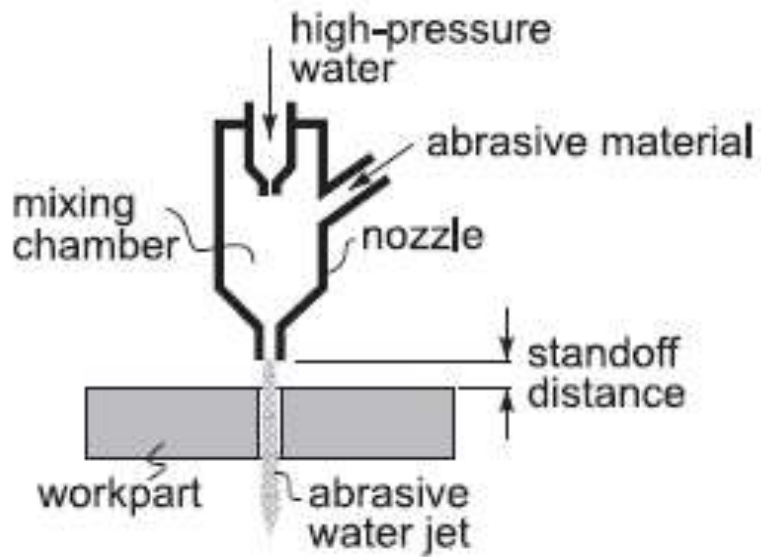

Abrasive Water Jet Cutting.



Abrasive Jet Cutter.

Continue..

- Abrasive Water Jet Cutting process was developed in 1960s to cut materials that cannot stand high temperatures for stress distortion or metallurgical reasons such as wood and composites, and traditionally difficult-to-cut materials, e.g. ceramics, glass, stones, titanium alloys



Ultrasonic machining

- **History**
- The roots of ultrasonic technology can be traced back to research on the piezoelectric effect conducted by Pierre Curie around 1880.
- He found that asymmetrical crystals such as quartz and Rochelle salt (potassium sodium tetraborate) generate an electric charge when mechanical pressure is applied.
- Conversely, mechanical vibrations are obtained by applying electrical oscillations to the same crystals.
- Frequency values of up to 1Ghz (1 billion cycles per second) have been used in the ultrasonic industry.
- Today's Ultrasonic applications include medical imaging (scanning the unborn fetus) and testing for cracks in airplane construction.

Ultrasonic Waves

- The Ultrasonic waves are sound waves of frequency higher than 20,000 Hz.
- Ultrasonic waves can be generated using mechanical, electromagnetic and thermal energy sources.
- They can be produced in gasses (including air), liquids and solids.
- Magnetostrictive transducers use the inverse magnetostrictive effect to convert magnetic energy into ultrasonic energy
- This is accomplished by applying a strong alternating magnetic field to certain metals, alloys and ferrites

Continue..

- Piezoelectric transducers employ the inverse piezoelectric effect using natural or synthetic single crystals (such as quartz) or ceramics (such as barium titanate) which have strong piezoelectric behavior.
- Ceramics have the advantage over crystals in that they are easier to shape by casting, pressing and extruding.

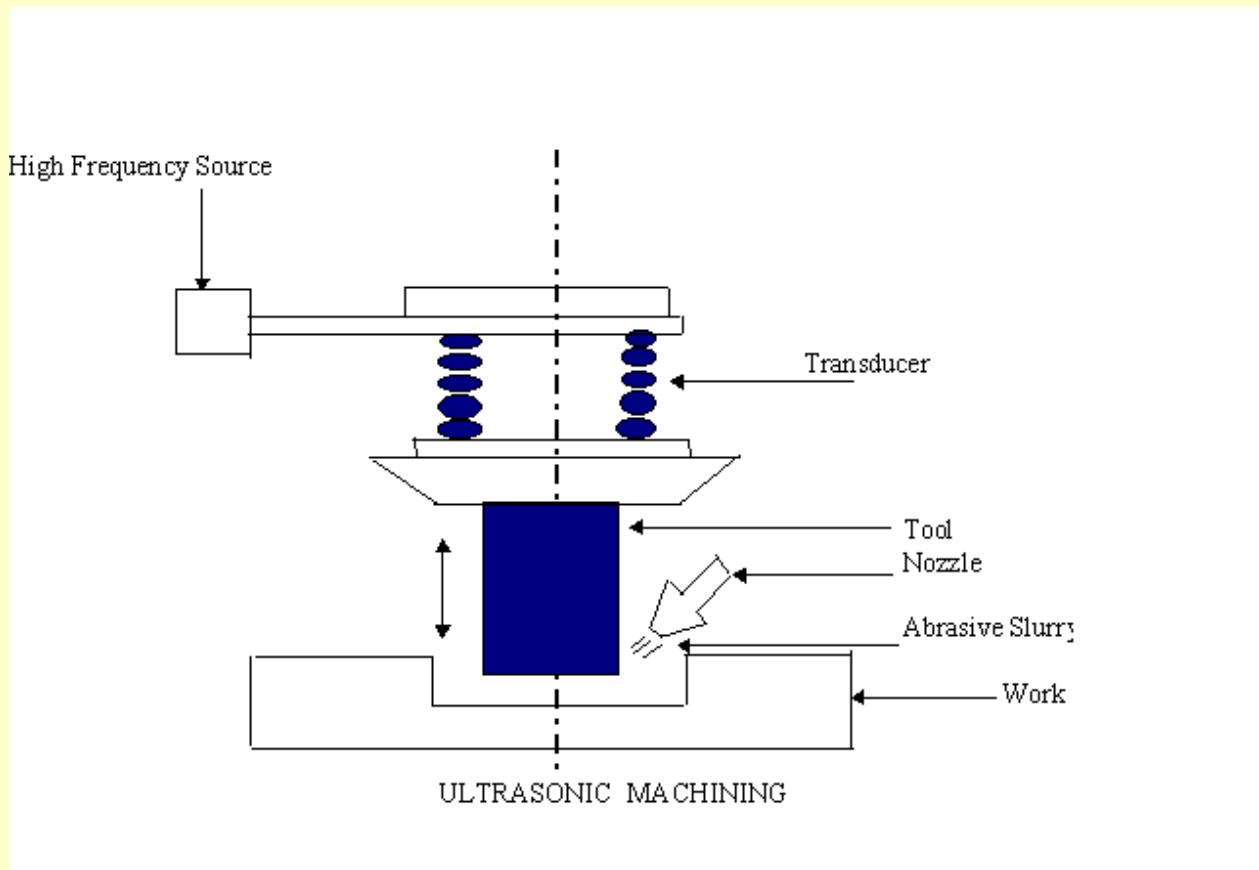

1- This is the standard mechanism used in most of the universal Ultrasonic machines

Principle of machining

- In the process of Ultrasonic Machining, material is removed by micro-chipping or erosion with abrasive particles.
- In USM process, the tool, made of softer material than that of the workpiece, is oscillated by the Booster and Sonotrode at a frequency of about 20 kHz with an amplitude of about 25.4 μm (0.001 in).
- The tool forces the abrasive grits, in the gap between the tool and the workpiece, to impact normally and successively on the work surface, thereby machining the work surface.
- During one strike, the tool moves down from its most upper remote position with a starting speed at zero, then it speeds up to finally reach the maximum speed at the mean position.

Continue..

- Then the tool slows down its speed and eventually reaches zero again at the lowest position.
- When the grit size is close to the mean position, the tool hits the grit with its full speed
- The smaller the grit size, the lesser the momentum it receives from the tool.
- Therefore, there is an effective speed zone for the tool and, correspondingly there is an effective size range for the grits.
- In the machining process, the tool, at some point, impacts on the largest grits, which are forced into the tool and work piece.

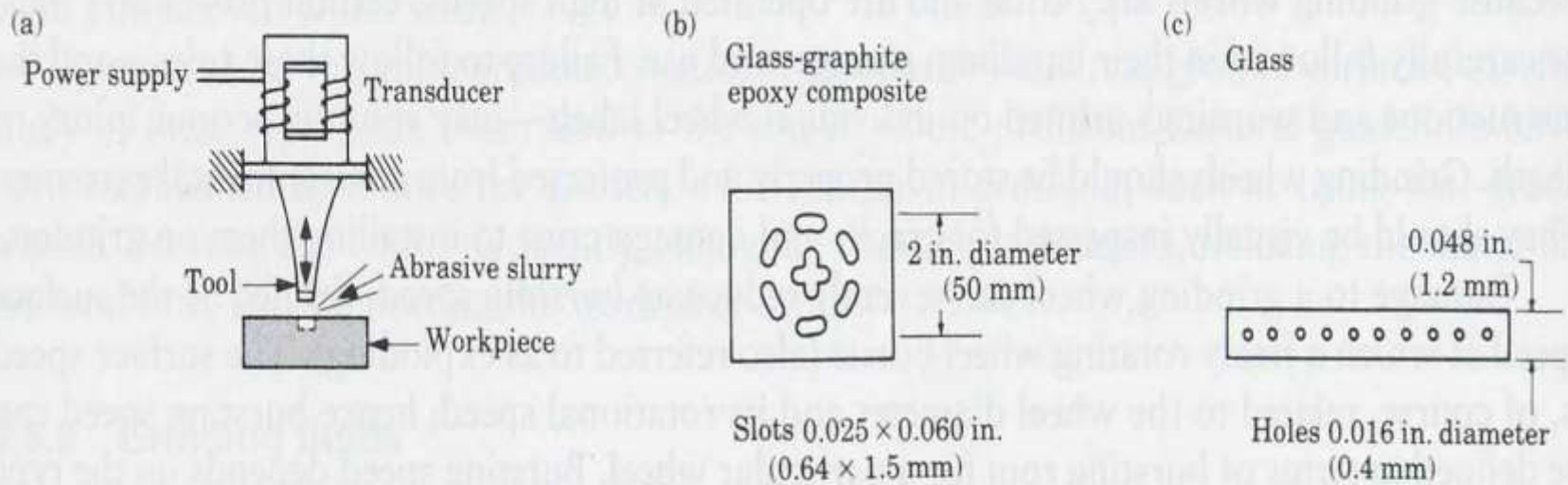
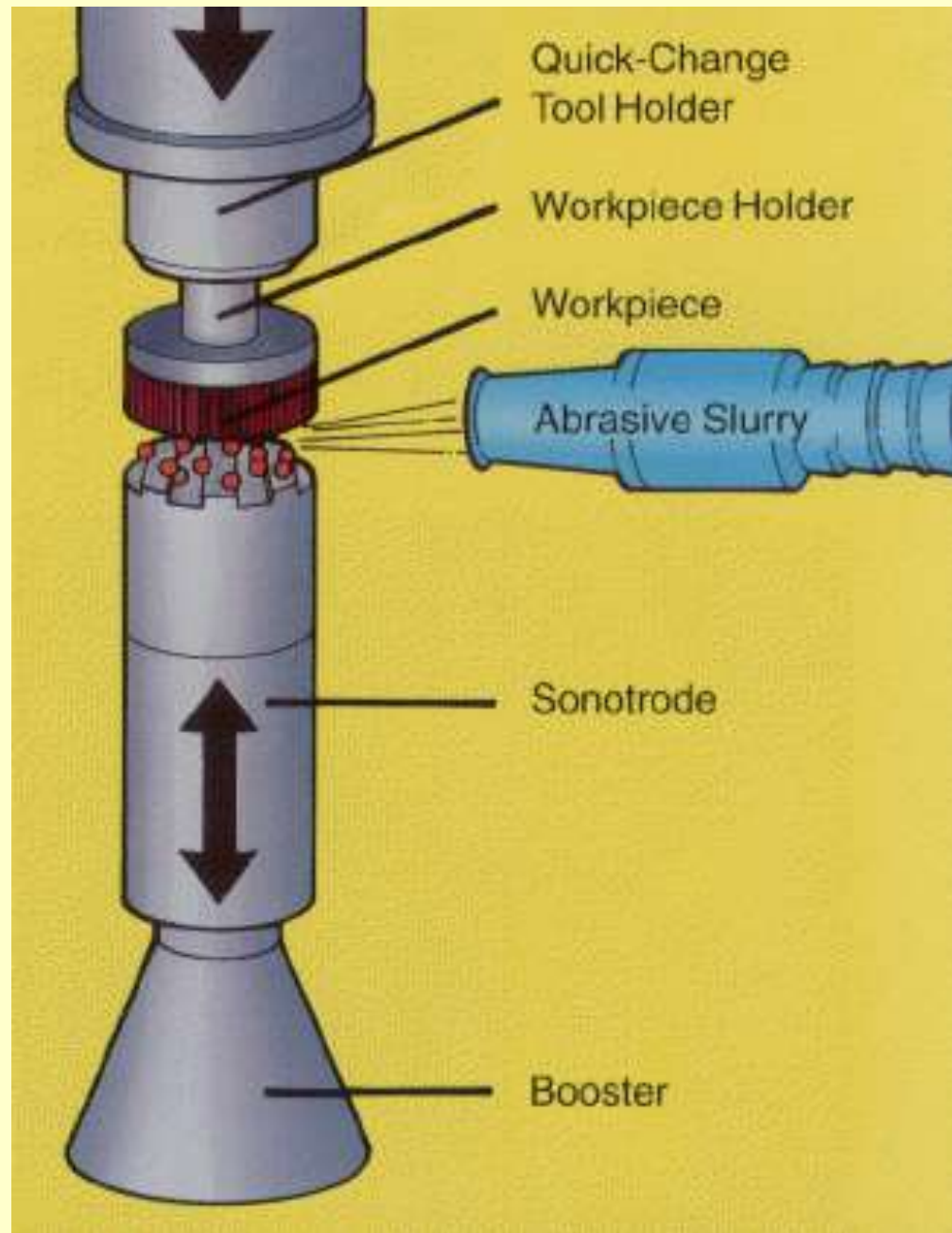

FIGURE 9.22 (a) Schematic illustration of the ultrasonic machining process by which material is removed by microchipping and erosion. (b) and (c) Typical examples of holes produced by ultrasonic machining. Note the dimensions of cut and the types of workpiece materials.

Continue..

- As the tool continues to move downwards, the force acting on these grits increases rapidly, therefore some of the grits may be fractured.
- As the tool moves further down, more grits with smaller sizes come in contact with the tool, the force acting on each grit becomes less.
- Eventually, the tool comes to the end of its strike, the number of grits under impact force from both the tool and the workpiece becomes maximum.
- Grits with size larger than the minimum gap will penetrate into the tool and work surface to different extents according to their diameters and the hardness of both surfaces



Electrochemical Machining

- A popular application of electrolysis is the [electroplating](#) process in which metal coatings are deposited upon the surface of a cathodically polarized metal.
- ECM is similar to electro polishing in that it also is an anodic dissolution process. But the rates of metal removal offered by the polishing process are considerably less than those needed in metal machining practice .

Concept

- Metal removal is achieved by electrochemical dissolution of an anodically polarized workpiece which is one part of an electrolytic cell in ECM.
- when an electric current is passed between two conductors dipped into a liquid solution named as Electrolysis .
- Electrolytes are different from metallic conductors of electricity in that the current is carried not by electrons but by atoms, or group of atoms, which have either lost or gained electrons, thus acquiring either positive or negative charges. Such atoms are called ions.

Electrolytic dissolution of iron.

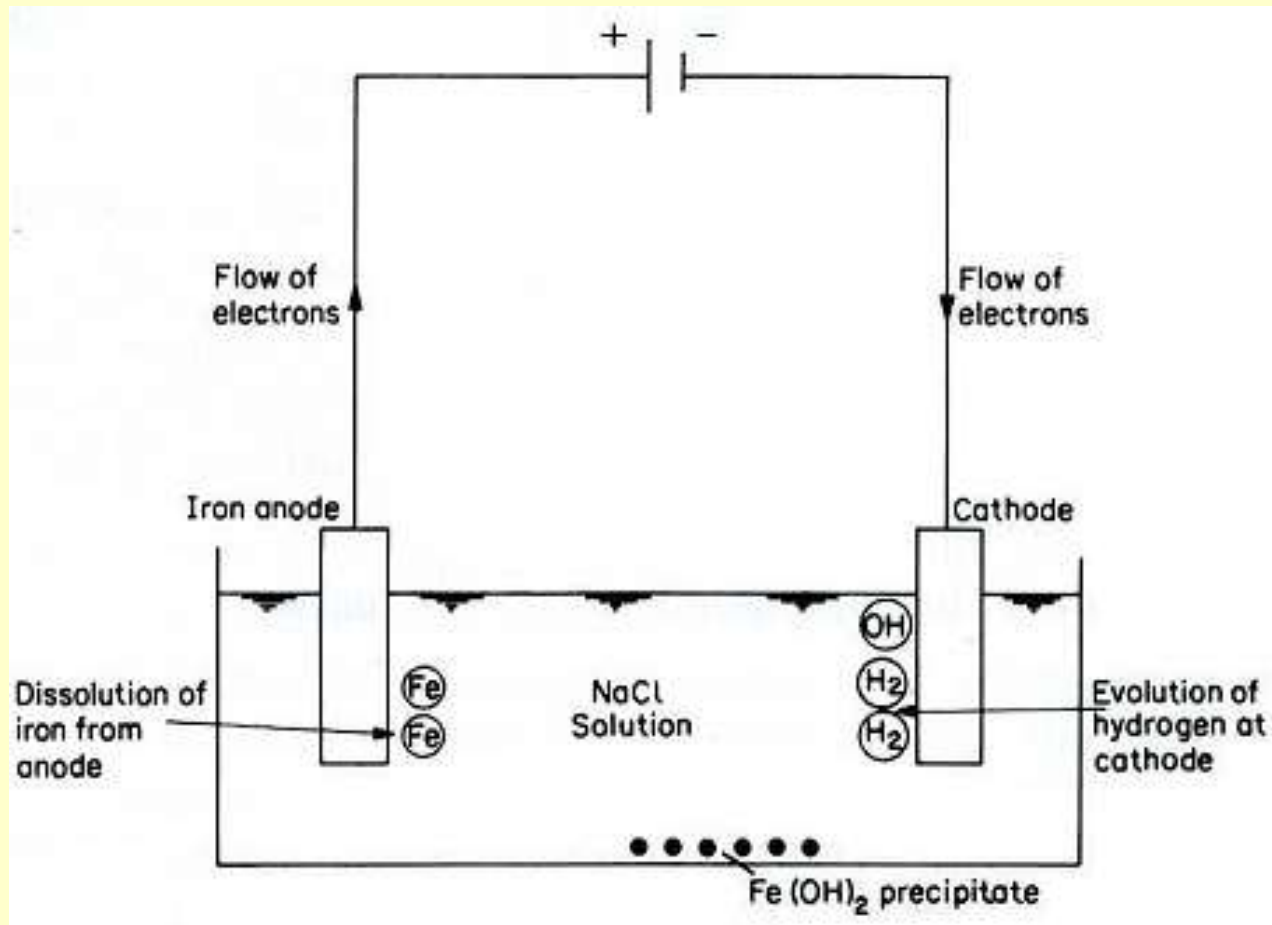

Continue..

- Ions which carry positive charges move through the electrolyte in the direction of the positive current, that is, toward the cathode, and are called cations.
- The negatively charged ions travel toward the anode and are called anions.
- The movement of the ions is accompanied by the flow of electrons, in the opposite sense to the positive current in the electrolyte.
- Both reactions are a consequence of the applied potential difference, that is, voltage, from the electric source.

Working Principle

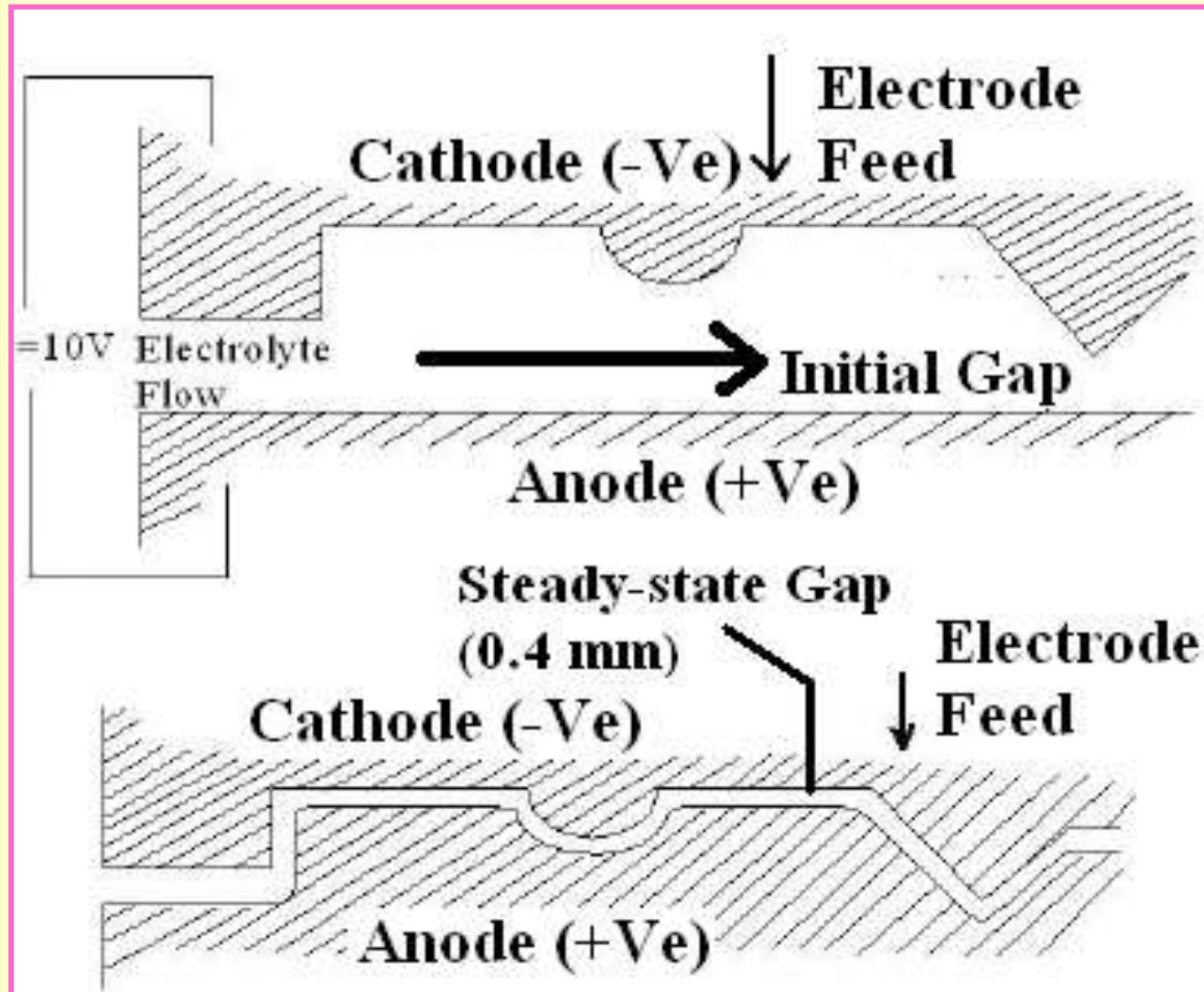

Continue..

- the workpiece and tool are the anode and cathode, respectively, of an electrolytic cell, and a constant potential difference, usually at about 10 V, is applied across them.
- A suitable electrolyte, for example, aqueous sodium chloride (table salt) solution, is chosen so that the cathode shape remains unchanged during electrolysis.
- The electrolyte is also pumped at a rate 3 to 30 meter/second, through the gap between the electrodes to remove the products of machining and to diminish unwanted effects, such as those that arise with cathodic gas generation and electrical heating.
- The rate at which metal is then removed from the anode is approximately in inverse proportion to the distance between the electrodes

Continue..

- As machining proceeds, and with the simultaneous movement of the cathode at a typical rate, for example, 0.02 millimeter/second toward the anode.
- the gap width along the electrode length will gradually tend to a steady-state value. Under these conditions, a shape, roughly complementary to that of the cathode, will be reproduced on the anode.

Schematic diagram

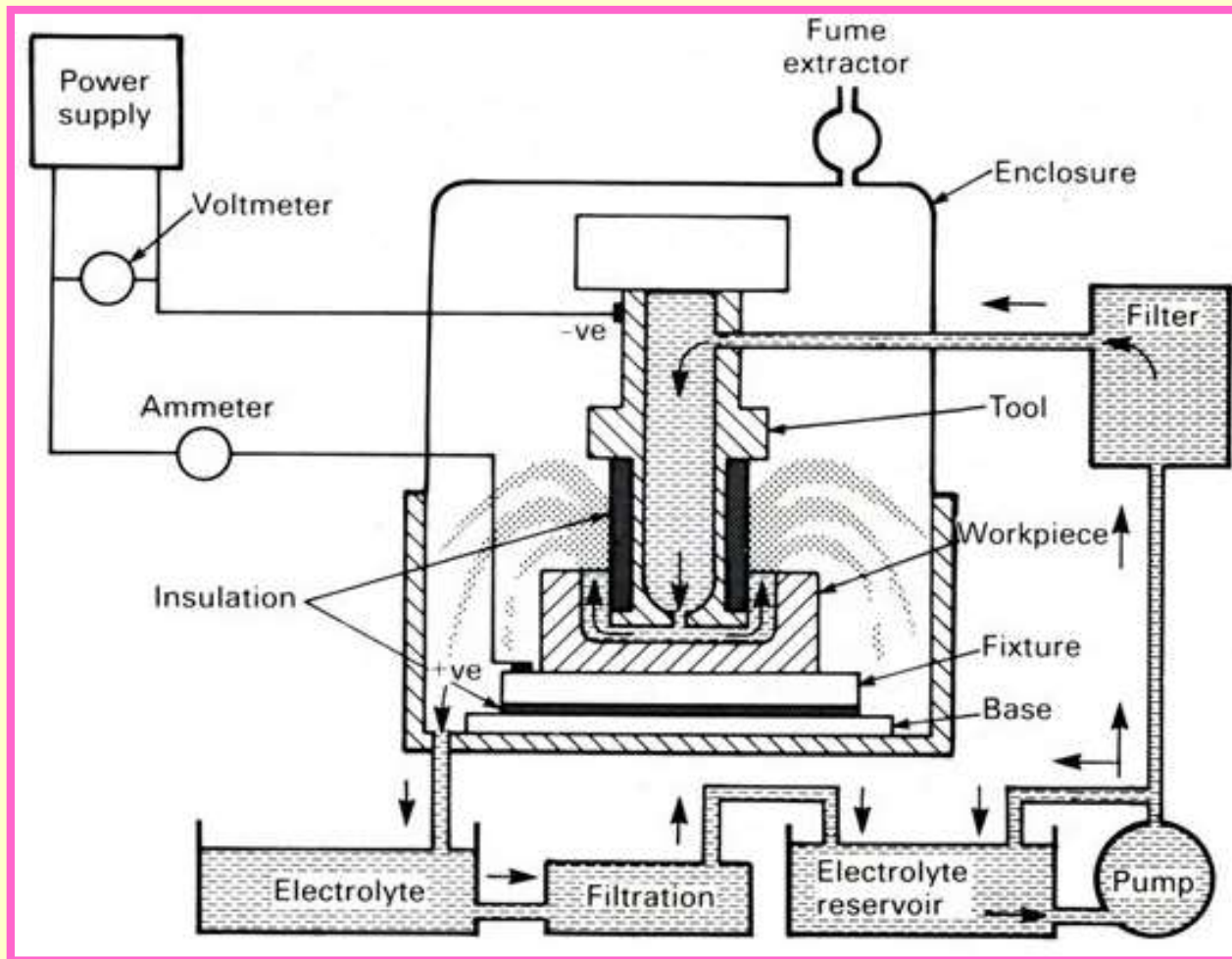

ECM Components (Power)

- The power needed to operate the ECM is obviously electrical. There are many specifications to this power.
- The current density must be high.
- The gap between the tool and the work piece must be low for higher accuracy, thus the voltage must be low to avoid a short circuit.
- The control system uses some of this electrical power.

ECM Components (electrolyte circulation system)

- The electrolyte must be injected in the gap at high speed (between 1500 to 3000 m/min).
- The inlet pressure must be between 0.15-3 MPa.
- The electrolyte system must include a fairly strong pump.
- System also includes a filter, sludge removal system, and treatment units.
- The electrolyte is stored in a tank.

ECM Components (control system)

- Control parameters include:
 - Voltage
 - Inlet and outlet pressure of electrolyte
 - Temperature of electrolyte.
- The current is dependant on the above parameters and the feed rate.

Advantages

- There is no cutting forces therefore clamping is not required except for controlled motion of the work piece.
- There is no heat affected zone.
- Very accurate.
- Relatively fast
- Can machine harder metals than the tool
- Faster than EDM
- No tool wear at all.
- No heat affected zone.
- Better finish and accuracy.

Disadvantages

- More expensive than conventional machining.
- Need more area for installation.
- Electrolytes may destroy the equipment.
- Not environmentally friendly (sludge and other waste)
- High energy consumption.
- Material has to be electrically conductive.

Applications

- The most common application of ECM is high accuracy duplication. Because there is no tool wear, it can be used repeatedly with a high degree of accuracy.
- It is also used to make cavities and holes in various products.
- Sinking operations (RAM ECM) are also used as an alternative to RAM EDM.
- It is commonly used on thin walled, easily deformable and brittle material because they would probably develop cracks with conventional machining.

Products

- The two most common products of ECM are turbine/compressor blades and rifle barrels.
- Each of those parts require machining of extremely hard metals with certain mechanical specifications that would be really difficult to perform on conventional machines.
- Some of these mechanical characteristics achieved by ECM are:
 - Stress free grooves.
 - Any groove geometry.
 - Any conductive metal can be machined.
 - Repeatable accuracy of 0.0005”.
 - High surface finish.
 - Fast cycle time.

Economics

- The process is economical when a large number of complex identical products need to be made (at least 50 units).
- Several tools could be connected to a cassette to make many cavities simultaneously. (i.e. cylinder cavities in engines).
- Large cavities are more economical on ECM and can be processed in 1/10 the time of EDM.

ELECTROCHEMICAL GRINDING

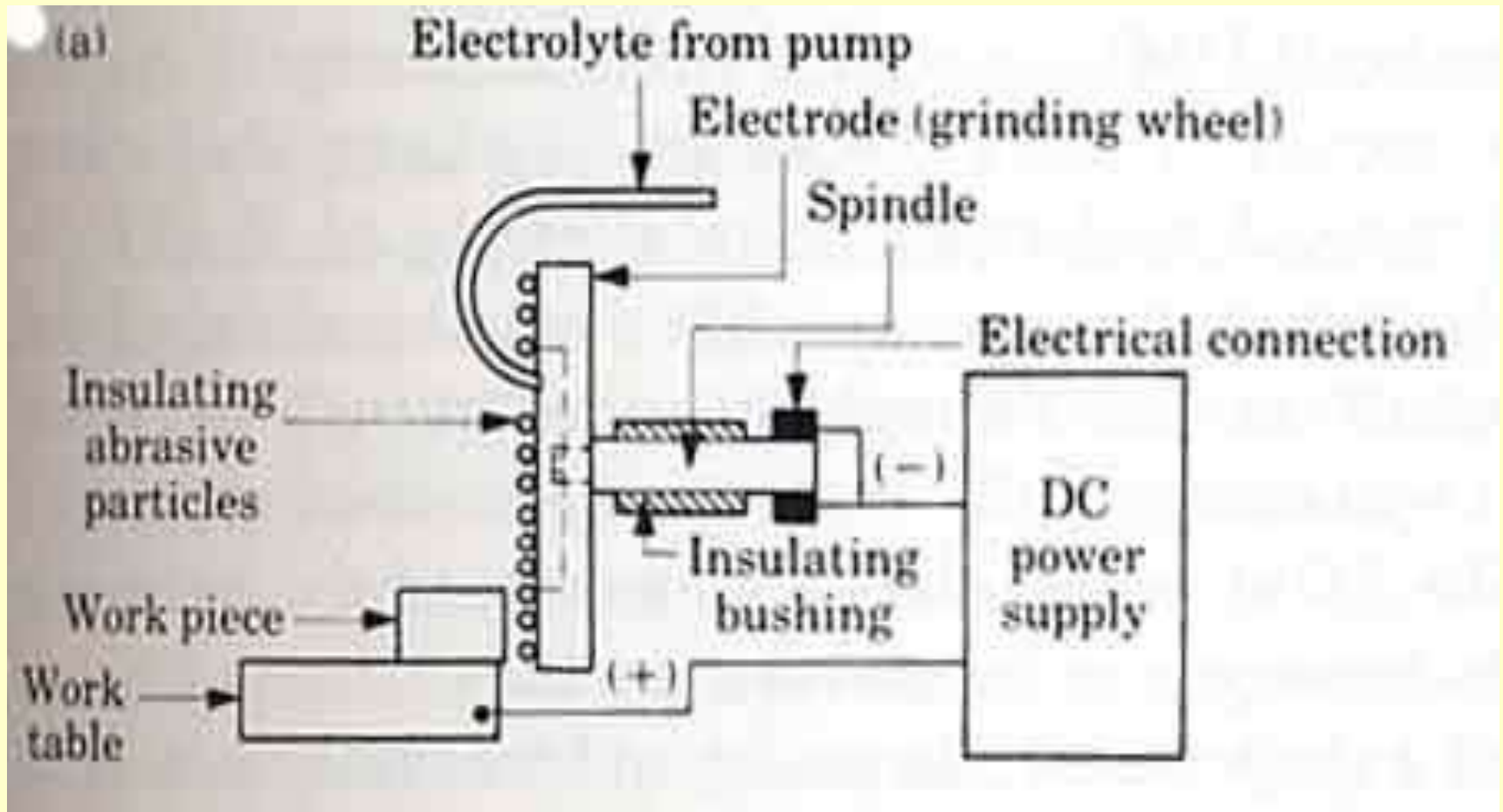

Concept

- The main feature of electrochemical grinding (ECG) is the use of a grinding wheel in which an insulating abrasive, such as diamond particles, is set in a conducting material. This wheel becomes the cathode tool .
- The non conducting particles act as a spacer between the wheel and workpiece, providing a constant inter electrode gap, through which electrolyte is flushed.
- Accuracies achieved by ECG are usually about 0.125 millimeter. A drawback of ECG is the loss of accuracy when inside corners are ground. Because of the electric field effects, radii better than 0.25  0.375 millimeter can seldom be achieved
- A wide application of electrochemical grinding is the production of tungsten carbide cutting tools. ECG is also useful in the grinding of fragile parts such as hypodermic needles

Concept

- Combines electrochemical machining with conventional grinding.
- The equipment used is similar to conventional grinder except that the wheel is a rotating cathode with abrasive particles.
- The wheel is metal bonded with diamond or Al oxide abrasives.
- Abrasives serve as insulator between wheel and work piece. A flow of electrolyte (sodium nitrate) is provided for electrochemical machining.
- Suitable in grinding very hard materials where wheel wear can be very high in traditional grinding

Sample ECMed parts

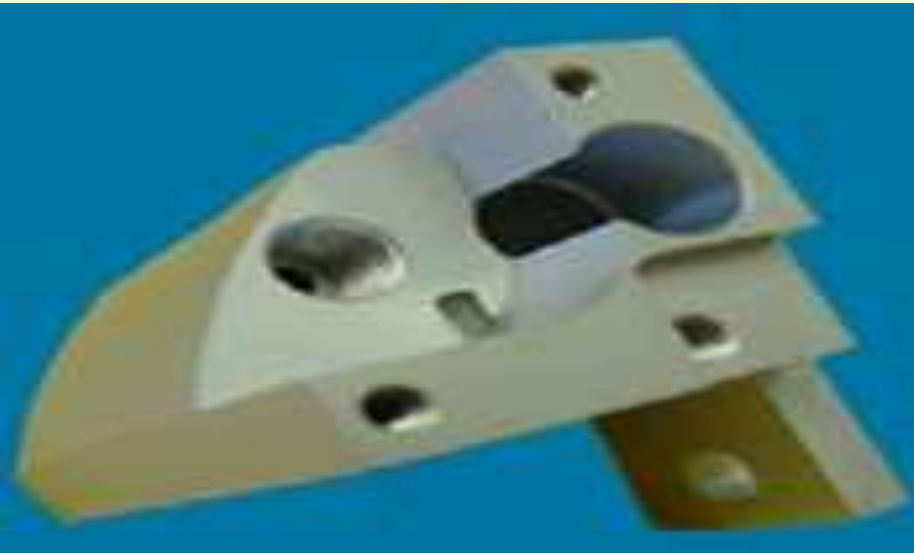



Lecture 1

Unconventional

Machining Process

TOPIC : INTRODUCTION OF UNCONVENTIONAL MACHINING PROCESS.

PREPARED BY: DR. UFAITH QADIRI

ASSOCIATE PROFESSOR

Introduction

- ▶ Unconventional manufacturing processes is defined as a group of processes that remove
- ▶ excess material by various techniques involving mechanical, thermal, electrical or chemical energy
- ▶ or combinations of these energies but do not use a sharp cutting tools as it needs to be used for traditional manufacturing processes.

Introduction Continue

- ▶ Extremely hard and brittle materials are difficult to machine by traditional machining
- ▶ processes such as turning, drilling, shaping and milling. Non traditional machining processes, also
- ▶ called advanced manufacturing processes, are employed where traditional machining processes are
- ▶ not feasible, satisfactory or economical due to special reasons as outlined below.

Continue

- Very hard fragile materials difficult to clamp for traditional machining
- When the work piece is too flexible or slender
- When the shape of the part is too complex

Types of Non-Conventional Energy Resources.

- ▶ Several types of non-traditional machining processes have been developed to meet extra required machining conditions. When these processes are employed properly, they offer many
- ▶ advantages over non-traditional machining processes. The common non- traditional machining
- ▶ processes are described in this section.

Manufacturing processes can be broadly divided into two groups

- a) Primary manufacturing processes: Provide basic shape and size
- b) Secondary manufacturing processes: Provide final shape and size with tighter control on dimension, surface characteristics

Material Removal Processes Once Again Can Be Divided Into Two Groups

1. Conventional Machining Processes
2. Non-Traditional Manufacturing Processes or Unconventional Machining processes

Conventional Machining Processes mostly remove material in the form of chips by applying forces on the work material with a wedge shaped cutting tool that is harder than the work material under machining condition.

THE MAJOR CHARACTERISTICS OF CONVENTIONAL MACHINING ARE:

- ▶ Generally macroscopic chip formation by shear deformation
- ▶ Material removal takes place due to application of cutting forces – energy domain can be Classified as mechanical
- ▶ Cutting tool is harder than work piece at room temperature as well as under machining Conditions

Non-conventional manufacturing processes is defined as a group of processes that remove excess material by various techniques involving mechanical, thermal, electrical or chemical energy or combinations of these energies but do not use a sharp cutting tools as it needs to be used for traditional manufacturing processes. Material removal may occur with chip formation or even no chip formation may take place. For example in AJM, chips are of microscopic size and in case of Electrochemical machining material removal occurs due to electrochemical dissolution at atomic level.

NEED FOR UNCONVENTIONAL MACHINING PROCESSES

- ▶ Extremely hard and brittle materials or Difficult to machine material are difficult to Machine by traditional machining processes.
- ▶ When the work piece is too flexible or slender to support the cutting or grinding Forces when the shape of the part is too complex.

Explanation of Ultrasonic Machining:

- ▶ During machining, the equal and opposite reaction, impact loads produced by the work piece will be acting on to the tool, so that if the tool is made by using the hard material, the brittle fracturing is taking place in the tool also and the tool wear becomes higher.
- ▶ To minimize this, the tool must be made by using a material which has very high softness(ductility).
- ▶ For Example, Copper, Brass, Mild steel, etc.
- ▶ With an increase of grain size or abrasive particle size, the material removal rate is increasing first and then decreasing.

continue

- ▶ As the percentage of abrasive particles in the slurry is increasing the material removal rate is increasing but the flow characteristics of the slurry are decreasing.
- ▶ Therefore the optimum percentage of abrasives in the slurry is 40-60%.
- ▶ Wear ratio mainly depends on the brittleness of workpiece material i.e. the higher the brittleness, it is easy to produce the brittle fracturing. Hence, the wear ratio becomes higher.

Advantages of Ultrasonic Machining Process (USM):

- ▶ Highly brittle materials can be easily machineable.
- ▶ Circular, non-circular of very small size is <1 mm size can be produced by using this USM method.
- ▶ Out of all the non-traditional machining methods, ultrasonic machining requires lower specific cutting energy.
- ▶ No electrical conductivity of the workpiece is required.
- ▶ No thermal effects on the workpiece are required.

Disadvantages of Ultrasonic Machining Process (USM):

- ▶ Only brittle materials can be Machinable.
- ▶ A deeper hole is not possible to produce i.e. L/D ratio up to 3 only is produced.
- ▶ Because of brittle fracturing, the surface finish produced is poor.
- ▶ Because of impact loads are acting on to the workpiece, the internal residual stresses may be generated in the workpiece.

Applications of Ultrasonic Machining Process (USM):

- ▶ This ultrasonic machining method is mainly used for producing circular, non-circular holes in the highly brittle materials like glass, ceramics, etc.
- ▶ The dentist uses ultrasonic machining for producing the holes in the human teeth.

Ultrasonic Machining Process

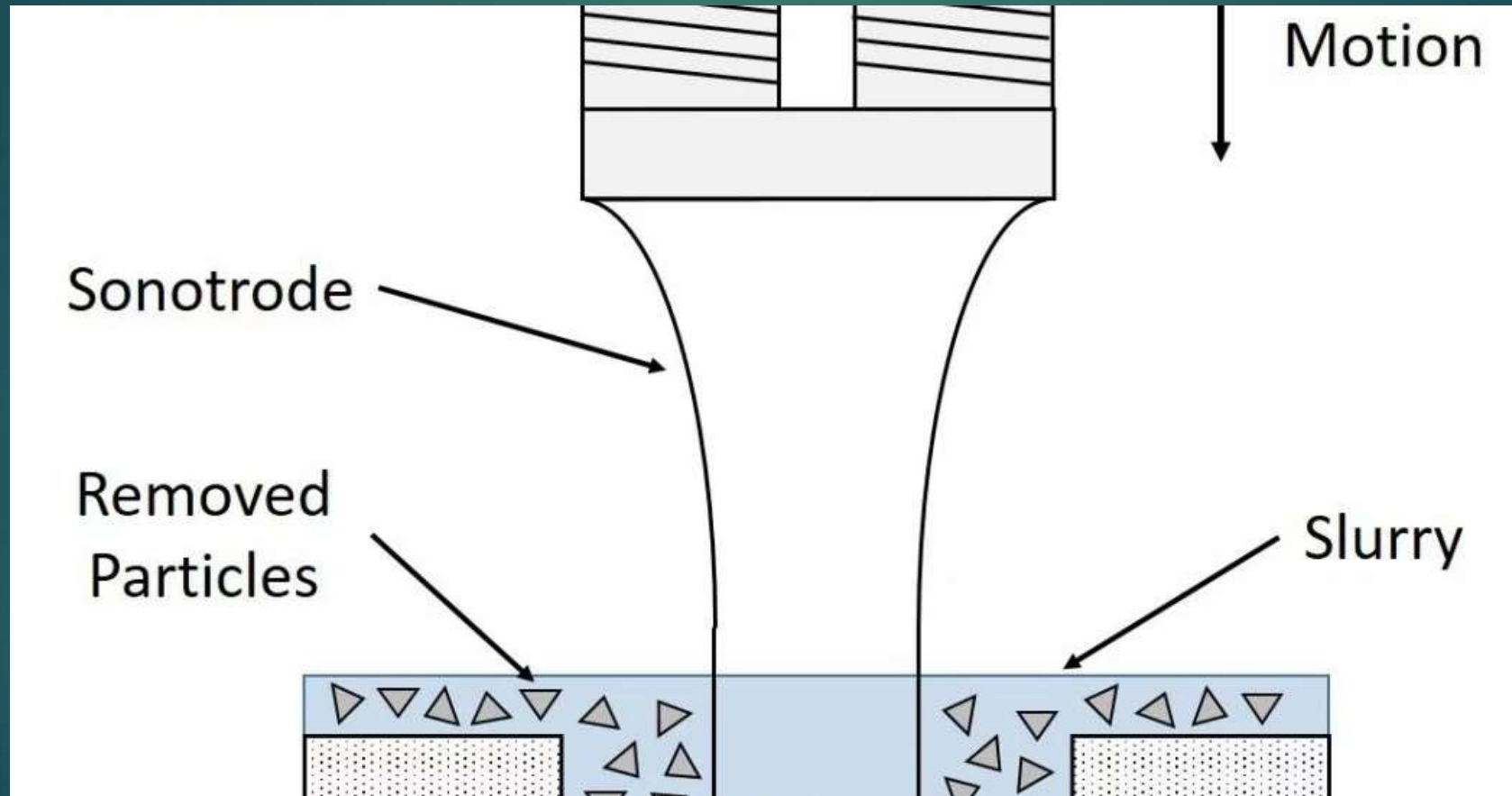

CLASSIFICATION OF UCM PROCESSES:

▶ 1. Mechanical Processes

- Abrasive Jet Machining (AJM)
- Abrasive Water Jet Machining (AWJM)
- Water Jet Machining (WJM)
- Ultrasonic Machining (USM)

Electrochemical Processes

- ▶ Electrochemical Machining (ECM)
- ▶ Electro Chemical Grinding (ECG)
- ▶ Electro Jet Drilling (EJD)

Electro-Thermal Processes

- ▶ Electro-discharge machining (EDM)
- ▶ Laser Jet Machining (LJM)
- ▶ Electron Beam Machining (EBM)

Chemical Processes

- ▶ Chemical Milling (CHM)
- ▶ Photochemical Milling (PCM)

BRIEF OVERVIEW

1. ULTRA SONIC MACHINING

- ▶ USM is a mechanical material removal process in which the material is removed by
- ▶ repetitive impact of abrasive particles carried in liquid medium on to the work surface, by a
- ▶ shaped tool, vibrating at ultrasonic frequency.

2 .ABRASIVE JET MACHINING

- ▶ It is the material removal process where the material is removed or machined by the
- ▶ impact erosion of the high velocity stream of air or gas and abrasive mixture, which is focused
- ▶ on to the work piece.

LASER BEAM MACHINING

- ▶ Laser-beam machining is a thermal material-removal process that utilizes a high- Energy,
- ▶ Coherent light beam to melt and vaporize particles on the surface of metallic and non- Metallic work
- ▶ pieces. Lasers can be used to cut, drill, weld and mark. LBM is particularly suitable for making
- ▶ accurately placed holes

ELECTRON BEAM MACHINING

- ▶ It is the thermo-electrical material removal process on which the material is
- ▶ removed by the high velocity electron beam emitted from the tungsten filament made to
- ▶ impinge on the work surface, where kinetic energy of the beam is transferred to the work
- ▶ piece material, producing intense heat, which makes the material to melt or vaporize it locally.

ELECTRO CHEMICAL MACHINING

- ▶ It is the controlled removal of metals by the anodic dissolution in an electrolytic medium, where
- ▶ the work piece (anode) and the tool (cathode) are connected to the electrolytic circuit, which is kept,
- ▶ immersed in the electrolytic medium

ELECTRO CHEMICAL GRINDING

- ▶ ECG is the material removal process in which the material is removed by the combination of
- ▶ Electro- Chemical decomposition as in ECM process and abrasive due to grinding.
- ▶ **7. PLASMA ARC MACHINING**
- ▶ Plasma is defined as the gas, which has been heated to a sufficiently high temperature to
- ▶ Become ionized.

Unit II :MECHANICAL ENERGY BASED MACHINING

ABRASIVE JET MACHINING (AJM)

- ▶ In Abrasive Jet Machining (AJM), abrasive particles are made to impinge on the work material at a high velocity. The high velocity abrasive particles remove the material by micro-cutting action as well as brittle fracture of the work material.
- ▶ In AJM, generally, the abrasive particles of around 50 μm grit size would impinge on the work material at velocity of 200 m/s from a nozzle of I.D. of 0.5 mm with a standoff distance of around 2 mm. The kinetic energy of the abrasive particles would be sufficient to provide material removal due to brittle fracture of the work piece or even micro cutting by the abrasives.

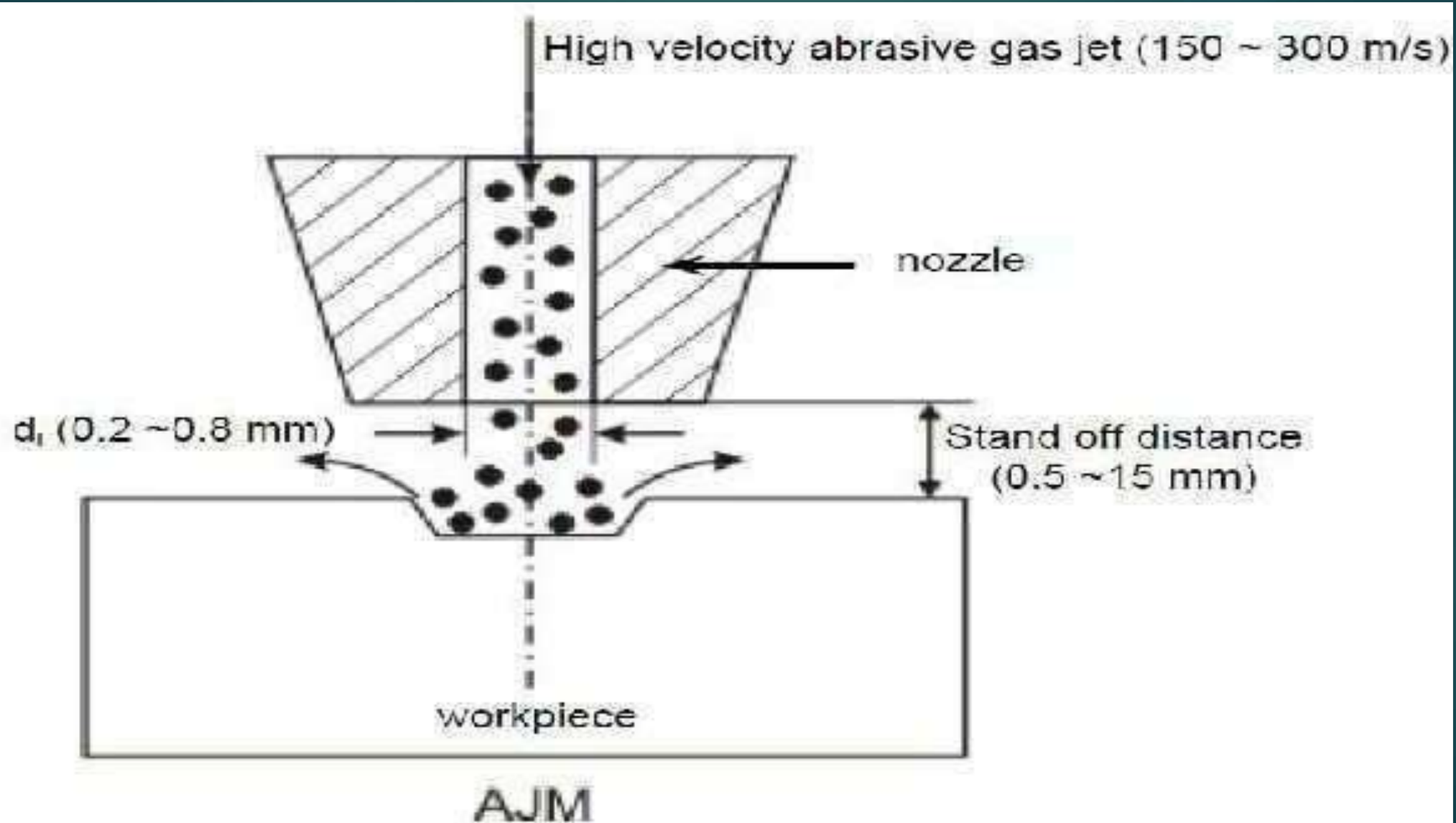

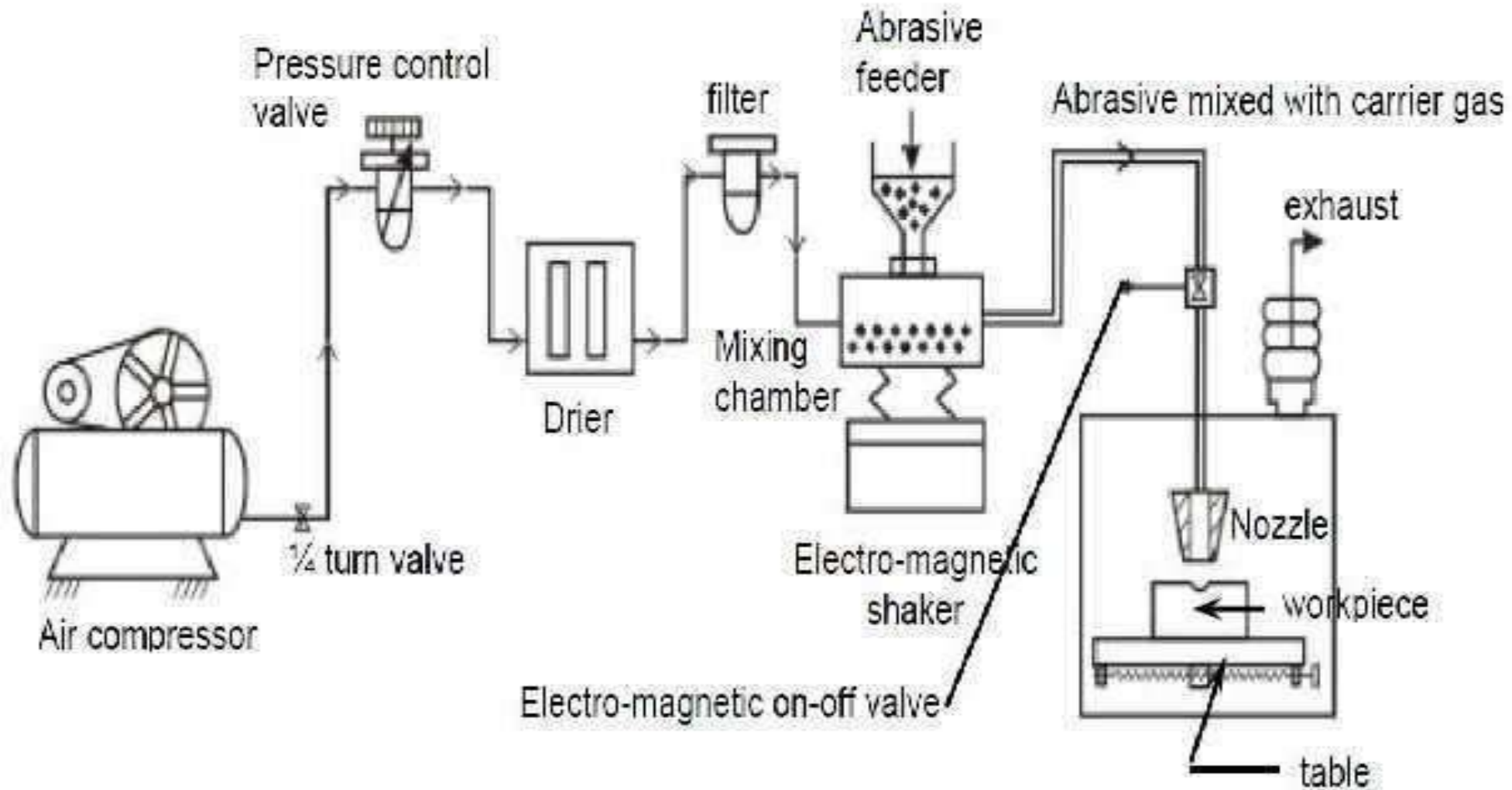

SCHEMATIC DIAGRAM OF AJM

Process Parameters and Machining Characteristics

- ▶ Abrasive: Material – Al₂O₃ / SiC / glass beads
- ▶ Shape – irregular / spherical
- ▶ Size – 10 ~ 50 μm
- ▶ Mass flow rate – 2 ~ 20 gm/min
- ▶ Carrier gas : Composition – Air, CO₂, N₂ Density – Air ~ 1.3kg/m³
- ▶ Velocity – 500 ~ 700m/s
- ▶ Pressure – 2 ~ 10 bar Flow rate – 5 ~ 30 lpm
- ▶ Abrasive Jet : Velocity – 100 ~ 300 m/s



Mixing ratio – mass flow ratio of abrasive to gas

Stand-off distance – 0.5 ~ 5 mm

Impingement Angle – 60° ~ 90° Nozzle :

Material – WC

Diameter –(Internal) 0.2 ~ 0.8 mm

Life—10~300hours Modelling of material removal

Material removal in AJM takes place due to brittle fracture of the work material due to impact of high velocity abrasive particles.

Modelling has been done with the following assumptions:

- a) Abrasives are spherical in shape and rigid. The particles are characterized by the mean grit diameter
- b) The kinetic energy of the abrasives are fully utilized in removing material
- c) Brittle materials are considered to fail due to brittle fracture and the fracture volume is considered to be hemispherical with diameter equal to chordal length of the indentation

Water Jet Machining (WJM)

Introduction

- ▶ Water jet cutting can reduce the costs and speed up the processes by eliminating or reducing expensive secondary machining process. Since no heat is applied on the materials, cut edges are clean with minimal burr. Problems such as cracked edge defects, crystallisation, hardening, reduced weld ability and machinability are reduced in this process.

Water jet technology uses the principle of pressurizing water to extremely high pressures, and allowing the water to escape through a very small opening called “orifice” or “jewel”. Water jet cutting uses the beam of water exiting the orifice to cut soft materials. This method is not suitable for cutting hard materials. The inlet water is typically pressurized between 1300 – 4000 bars. This high pressure is forced through a tiny hole in which is typically to 0.4 mm in diameter. A picture of water jet machining process

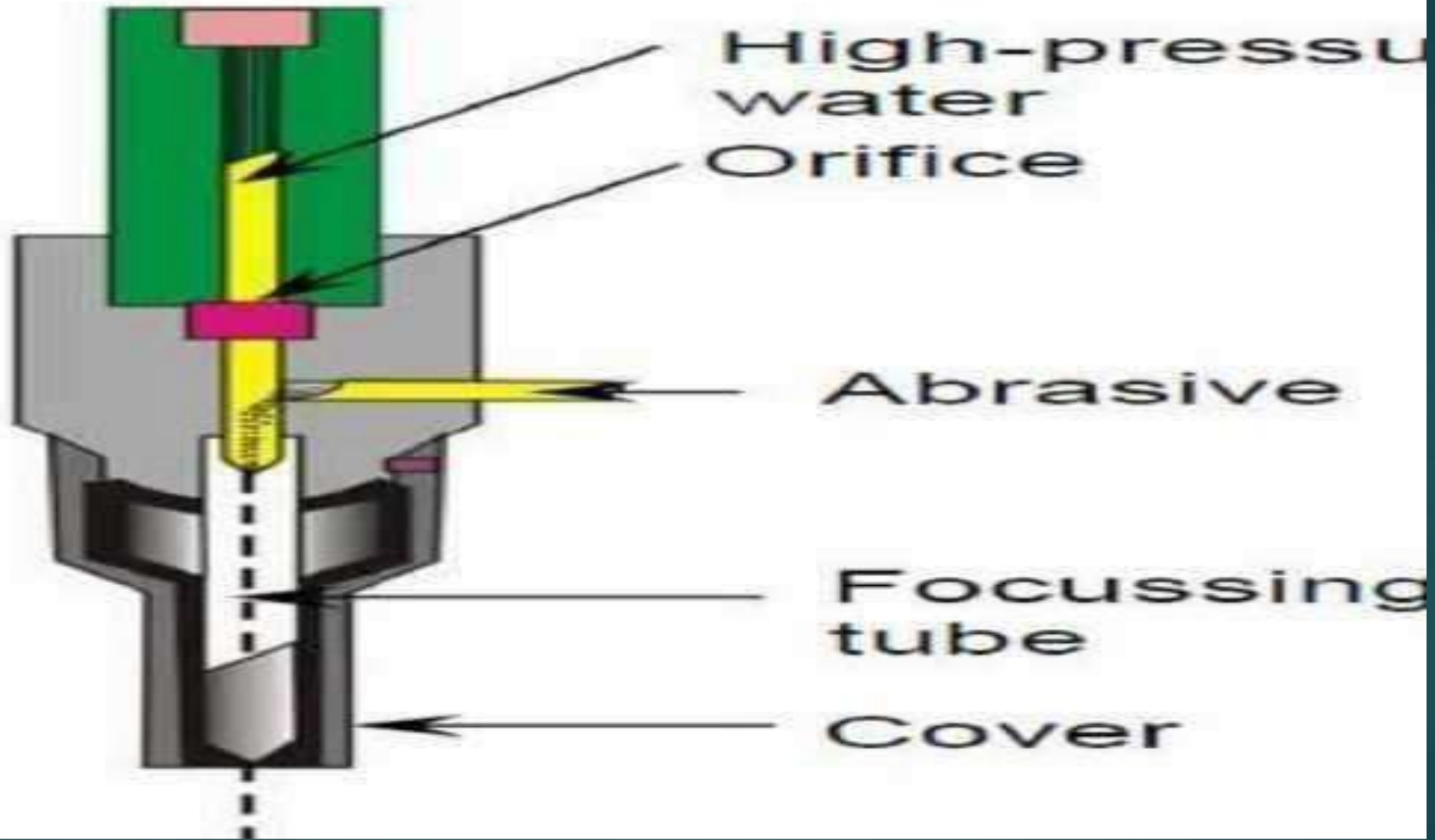

WATER JET MACHINING PROCESS

Water jet cutting Technology

Continue:

Applications

- ▶ Water jet cutting is mostly used to cut lower strength materials such as wood, plastics and aluminium. When abrasives are added, (abrasive water jet cutting) stronger materials such as steel and tool steel.
- ▶ **Advantages of water jet cutting**
- ▶ a) There is no heat generated in water jet cutting; which is especially useful for cutting tool steel and other metals where excessive heat may change the properties of the material.
- ▶ b) Unlike machining or grinding, water jet cutting does not produce any dust or particles that are harmful if inhaled.
- ▶ c) Other advantages are similar to abrasive water jet cutting

Disadvantages of water jet cutting

- ▶ a) One of the main disadvantages of water jet cutting is that a limited number of materials can be cut economically.
- ▶ b) Thick parts cannot be cut by this process economically and accurately
- ▶ c) Taper is also a problem with water jet cutting in very thick materials. Taper is when the jet exits the part at different angle than it enters the part, and cause dimensional inaccuracy.

ABRASIVE WATER-JET MACHINING (AWJM)

Introduction

- ▶ Abrasive water jet cutting is an extended version of water jet cutting; in which the water jet contains abrasive particles such as silicon carbide or aluminium oxide in order to increase the material removal rate above that of water jet machining. Almost any type of material ranging from hard brittle materials such as ceramics, metals and glass to extremely soft materials such as foam and rubbers can be cut by abrasive water jet cutting. The narrow cutting stream and computer controlled movement enables this process to produce parts accurately and efficiently.



This machining process is especially ideal for cutting materials that cannot be cut by laser or thermal cut. Metallic, non-metallic and advanced composite materials of various thicknesses can be cut by this process. This process is particularly suitable for heat sensitive materials that cannot be machined by processes that produce heat while machining.



The schematic of abrasive water jet cutting is shown in Figure which is similar to water jet cutting apart from some more features underneath the jewel; namely abrasive, guard and mixing tube. In this process, high velocity water exiting the jewel creates a vacuum which sucks abrasive from the abrasive line, which mixes with the water in the mixing tube to form a high velocity beam of abrasives.

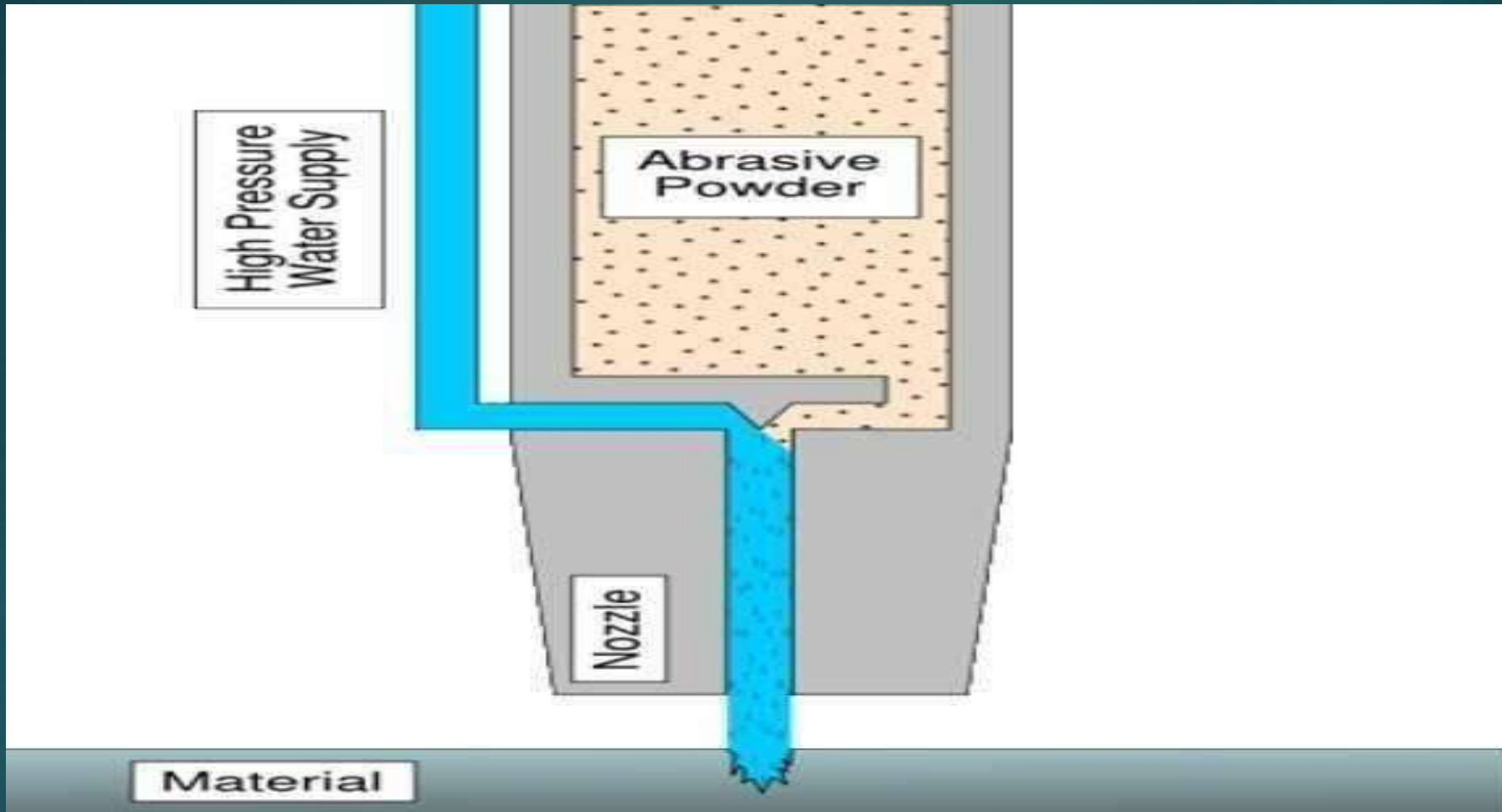

SCHEMATIC OF AWJM

Applications

Abrasive water jet cutting is highly used in aerospace, automotive and electronics industries. In aerospace industries, parts such as titanium bodies for military aircrafts, engine components (aluminium, titanium, and heat resistant alloys), aluminium body parts and interior cabin parts are made using abrasive water jet cutting.

In automotive industries, parts like interior trim (head liners, trunk liners, door panels) and fibre glass body components and bumpers are made by this process. Similarly, in electronics industries, circuit boards and cable stripping are made by abrasive water jet cutting.

Advantages of abrasive water jet cutting

- ▶ In most of the cases, no secondary finishing required
- ▶ a) No cutter induced distortion
- ▶ b) Low cutting forces on work pieces
- ▶ c) Limited tooling requirements
- ▶ d) Little to no cutting burr
- ▶ e) Typical finish 125-250microns
- ▶ f) Smaller kerf size reduces material wastages

- 
- a) No heat affected zone
 - b) Localizes structural changes
 - c) No cutter induced metal contamination
 - d) Eliminates thermal distortion
 - e) No slag or cutting dross
 - f) Precise, multi plane cutting of contours, shapes, and bevels of any angle.

Advanced Manufacturing Processes

Presented by:

Dr. Ufaith Qadiri

Associate Professor

Water Jet Machining WJM

Abrasive Water Jet Machining AWJM

Abrasive Jet Machining AJM



Water jet Machining

- **Introduction**
- **Principle**
- **The machining system**
- **Process Parameters**
- **Applications**
- **Advantages**
- **Disadvantages**

Introduction

- The key element in water jet machining (WJM) is a water jet, which travels at velocities as high as 900 m/s.
- When the stream strikes a workpiece surface, the erosive force of water removes the material rapidly.
- The water, in this case, acts like a saw and cuts a narrow groove in the workpiece material.
- WJM is a form of micro erosion. It works by forcing a large volume of water through a small orifice in the nozzle.

The machining system

- The water jet machining involves directing a high pressure (150-1000 MPa) high velocity (540-1400 m/s) water jet (faster than the speed of sound) to the surface to be machined. The fluid flow rate is typically from 0.5 to 2.5 L/min
- The bulk of kinetic energy of jet is converted into pressure energy.
- If the local pressure caused by the water jet exceeds the strength of the surface being machined, the material from the surface gets eroded and a cavity is thus formed.
- Water is the most common fluid used, but additives such as alcohols, oil products and glycerol are added when they can be dissolved in water to improve the fluid characteristics

The machining system

Water jet Machining consists of:

- Hydraulic Pump
- Intensifier
- Accumulator
- High Pressure Tubing
- Jet Cutting Nozzle
- Catcher

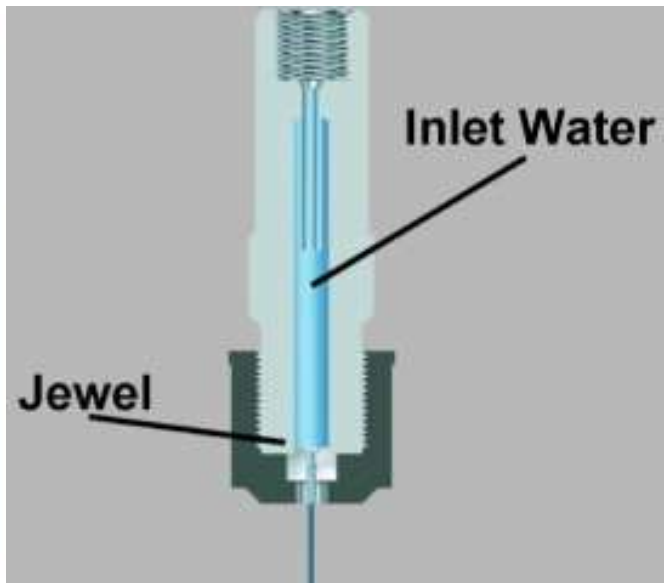
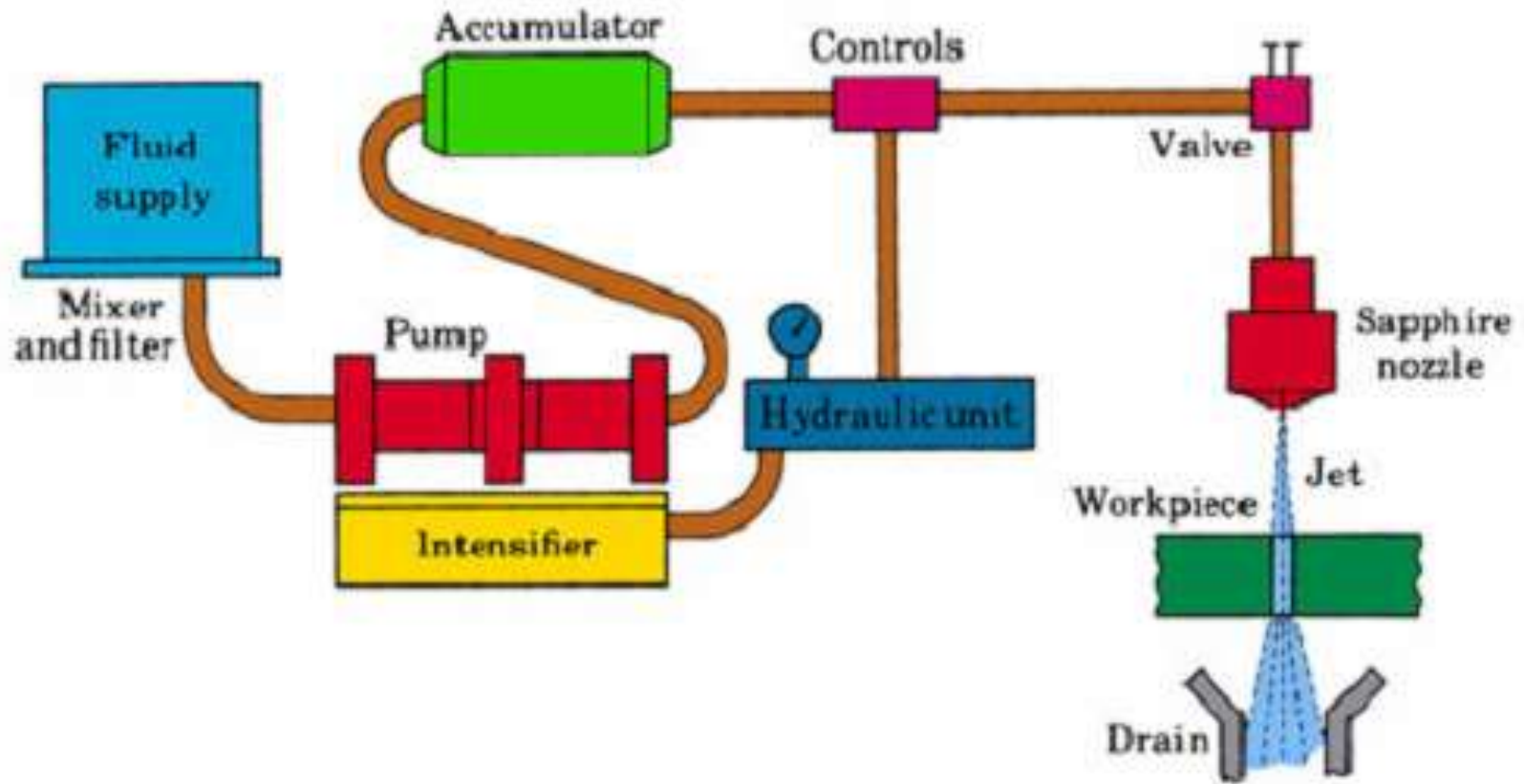

Hydraulic Pump

- Powered from a 30 kilowatt (kW) electric motor
- Supplies oil at pressures as high as 117 bars.
- Compressed oil drives a plunger pump termed an *intensifier*.
- The hydraulic pump offers complete flexibility for water jet cutting and cleaning applications.
- It also supports single or multiple cutting stations for increased machining productivity.

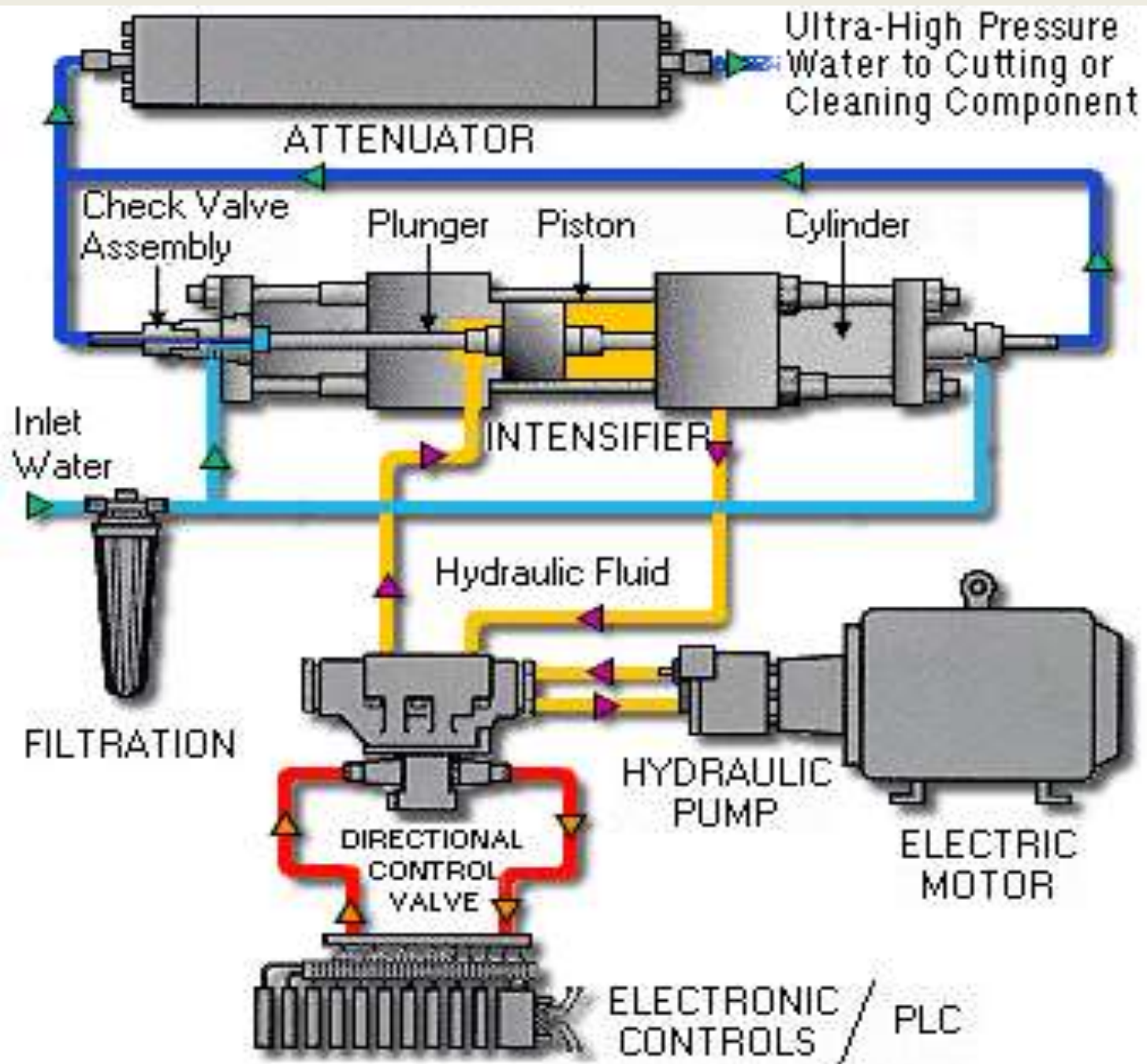

Intensifier

- Accepts the water at low pressure (typically 4 bar) and expels it, through an accumulator, at higher pressures of 3800 bar.
- The intensifier converts the energy from the low-pressure hydraulic fluid into ultrahigh-pressure water.
- The hydraulic system provides fluid power to piston in the intensifier center section.
- A limit switch, located at each end of the piston travel, signals the electronic controls to shift the directional control valve and reverses the piston direction.
- The intensifier assembly, with a plunger on each side of the piston, generates pressure in both directions.

Intensifier

- As one side of the intensifier is in the inlet stroke, the opposite side is generating ultrahigh-pressure output.
- During the plunger inlet stroke, filtered water enters the high-pressure cylinder through the check valve assembly.
- After the plunger reverses direction, the water is compressed and exits at ultrahigh pressure.

Accumulator

- Maintains the continuous flow of the high-pressure water and eliminates pressure fluctuations.
- It relies on the compressibility of water (12 percent at 3800 bar) in order to maintain a uniform discharge pressure and water jet velocity, when the intensifier piston changes its direction.

High Pressure Tubing

- Transports pressurized water to the cutting head.
- Typical tube diameters are 6 to 14 mm.
- The equipment allows for flexible movement of the cutting head.
- The cutting action is controlled either manually or through a remote-control valve specially designed for this purpose.

Jet Cutting Nozzle

- Nozzle provides a coherent water jet stream for optimum cutting of low-density, soft material that is considered un-machinable by conventional methods.
- Nozzles are normally made from synthetic sapphire.
- About 200 h of operation are expected from a nozzle, which becomes damaged by particles of dirt and the accumulation of mineral deposits on the orifice due to erosive water hardness.
- A longer nozzle life can be obtained through multistage filtration, which removes undesired solids of size greater than $0.45\ \mu\text{m}$.
- The compact design of the water jet cutting head promotes integration with motion control systems ranging from two-axis (*XY*) tables to sophisticated multi-axis robotic installations.

Catcher

- Acts as a reservoir for collecting the machining debris entrained in the water jet.
- Moreover, it reduces the noise levels [105 decibels (dB)] associated with the reduction in the velocity of the water jet from Mach 3 to subsonic levels.

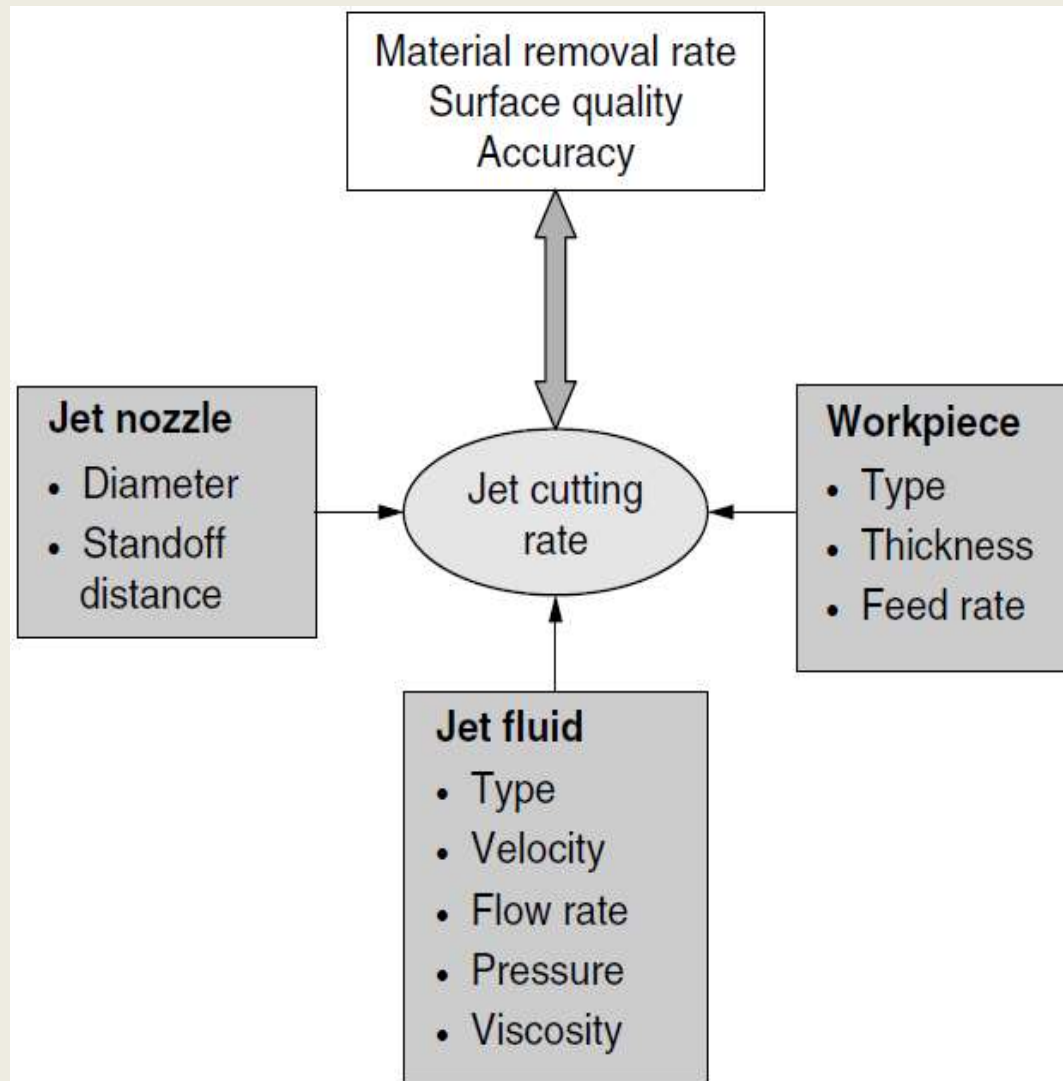

parameters affecting the performance of WJM

Process Parameters

JET NOZZLE

- Standoff distance - Gap between the jet nozzle (0.1–0.3 mm diameter) and the workpiece (2.5 – 6 mm).
- However for materials used in printed circuit boards, it may be increased to 13 to 19 mm.
- But larger the standoff distance, smaller would be the depth of cut.
- When cutting fiber-reinforced plastics, reports showed that the increase in machining rate and use of the small nozzle diameter increased the width of the damaged layer.

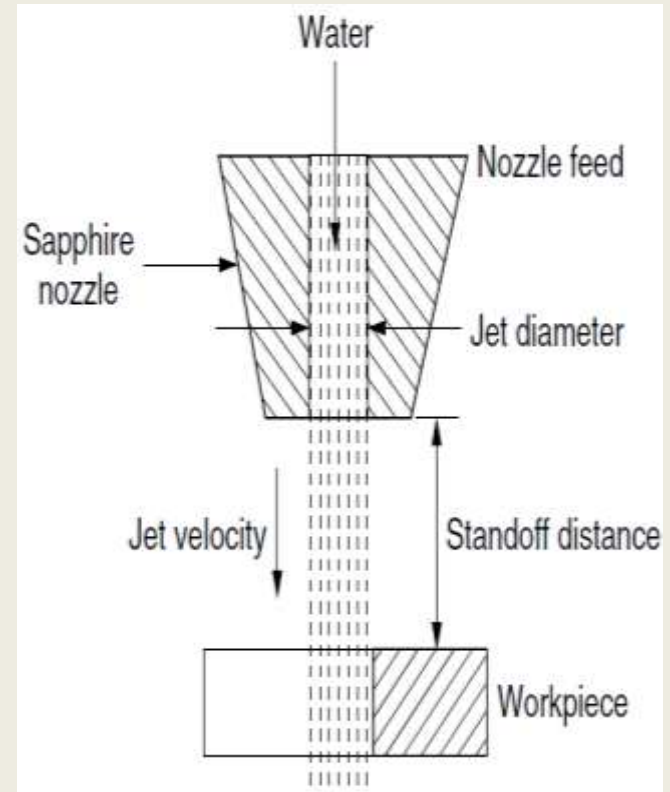

Jet Fluid

- Typical pressures used are 150 to 1000 MPa to provide 8 to 80 kW of power.
- For a given nozzle diameter, increase in pressure allows more power to be used in the machining process, which in turn increases the depth of the cut.
- Jet velocities range between 540 to 1400 m/s.
- The quality of cutting improves at higher pressures by widening the diameter of the jet and by lowering the traverse speed.
- Under such conditions, materials of greater thicknesses and densities can be cut.

Jet Fluid

- Moreover, the larger the pump pressure, the greater will be the depth of the cut.
- The fluid used must possess low viscosity to minimize the energy losses and be noncorrosive, and nontoxic.
- Water is commonly used for cutting alloy steels.

Workpiece

- Brittle materials will fracture, while ductile ones will cut well.
- Material thicknesses range from 0.8 to 25 mm or more.
- Table below shows the cutting rates for different material thicknesses

Material	Thickness, mm	Feed rate, m/min
Leather	2.2	20
Vinyl chloride	3.0	0.5
Polyester	2.0	150
Kevlar	3.0	3
Graphite	2.3	5
Gypsum board	10	6
Corrugated board	7	200
Pulp sheet	2	120
Plywood	6	1

Applications

- WJM is used on metals, paper, cloth, leather, rubber, plastics, food, and ceramics.
- It is a versatile and cost-effective cutting process that can be used as an alternative to traditional machining methods.
- It completely eliminates heat-affected zones, toxic fumes, recast layers, work hardening and thermal stresses.
- It is the most flexible and effective cleaning solution available for a variety of industrial needs.
- In general the cut surface has a sandblast appearance.
- Moreover, harder materials exhibit a better edge finish.
- Typical surface finishes ranges from 1.6 μm root mean square (RMS) to very coarse depending on the application..

- Both the produced surface roughness and tolerance depend on the machining speed
- **Cutting**
 - WJM is limited to fibreglass and corrugated wood.
- **Drilling**
 - The process drills precision-angled and -shaped holes in a variety of materials for which other processes such as EDM or EBM are too expensive or too slow.
- **Machining of fiber-reinforced plastics**
 - The feed rate attainable depends on the surface quality required.
- **Cutting of Rocks**
- **Deburring**
 - In this method burrs are broken off by the impact of water.

- **Cutting of PCBS (printed circuit boards)**

- Using a small-diameter water jet, a printed circuit board (PCB) can be cut at a speed that exceeds 8 m/min, to the accuracy of ± 0.13 mm.
- Boards of various shapes for use in portable radios and cassette players can be cut using computer numerical control (CNC) technology.



▪ **Surface Treatment**

- Removing deposits and residues without toxic chemicals, which eliminates costly cleanup and disposal problems.
- Surface cleaning of pipes and castings, decorative finishing, nuclear decontamination, food utensil cleaning, degreasing, polishing, preparation for precise inspection, and surface texturing.
- Economical surface preparation and coating removal.
- Removing corrosion, spray residue, soluble salts, chemicals, and surface damage prior to recoating or painting.

▪ **Wire Stripping**

- Can remove the wire insulating material without damaging the metal or removing the tinning on the copper wire.

Abrasive Water Jet Machining

- WJM is suitable for cutting plastics, foods, rubber insulation, automotive carpeting and headliners, and most textiles.
- The addition of abrasives to the water jet enhanced the material removal rate and produced cutting speeds between 51 and 460 mm/min.
- Generally, AWJM cuts 10 times faster than the conventional machining methods of composite materials.
- The introduction of compressed air to the water jet enhances the deburring action.

The machining system

- Water delivery
- Abrasive hopper and feeder
- Intensifier
- Filters
- Mixing chamber
- Cutting nozzles
- Catcher

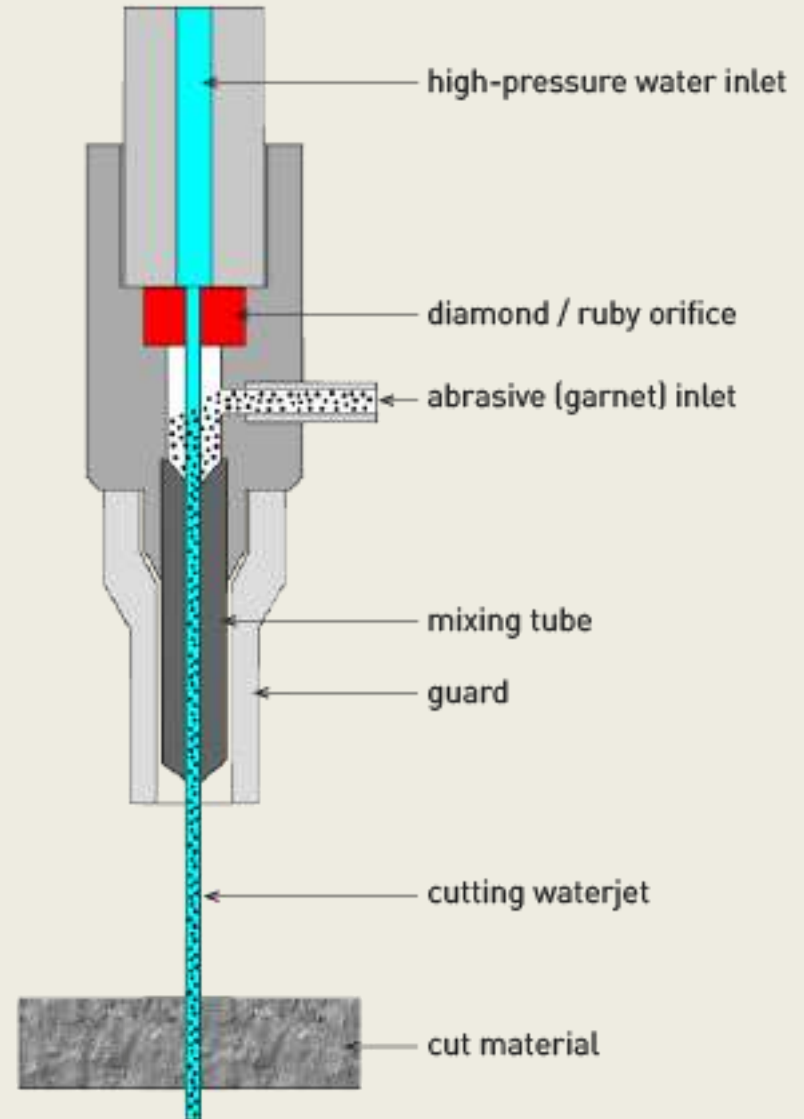

The machining system

- After the pure water jet is created, abrasives are added using either the injection or suspension methods

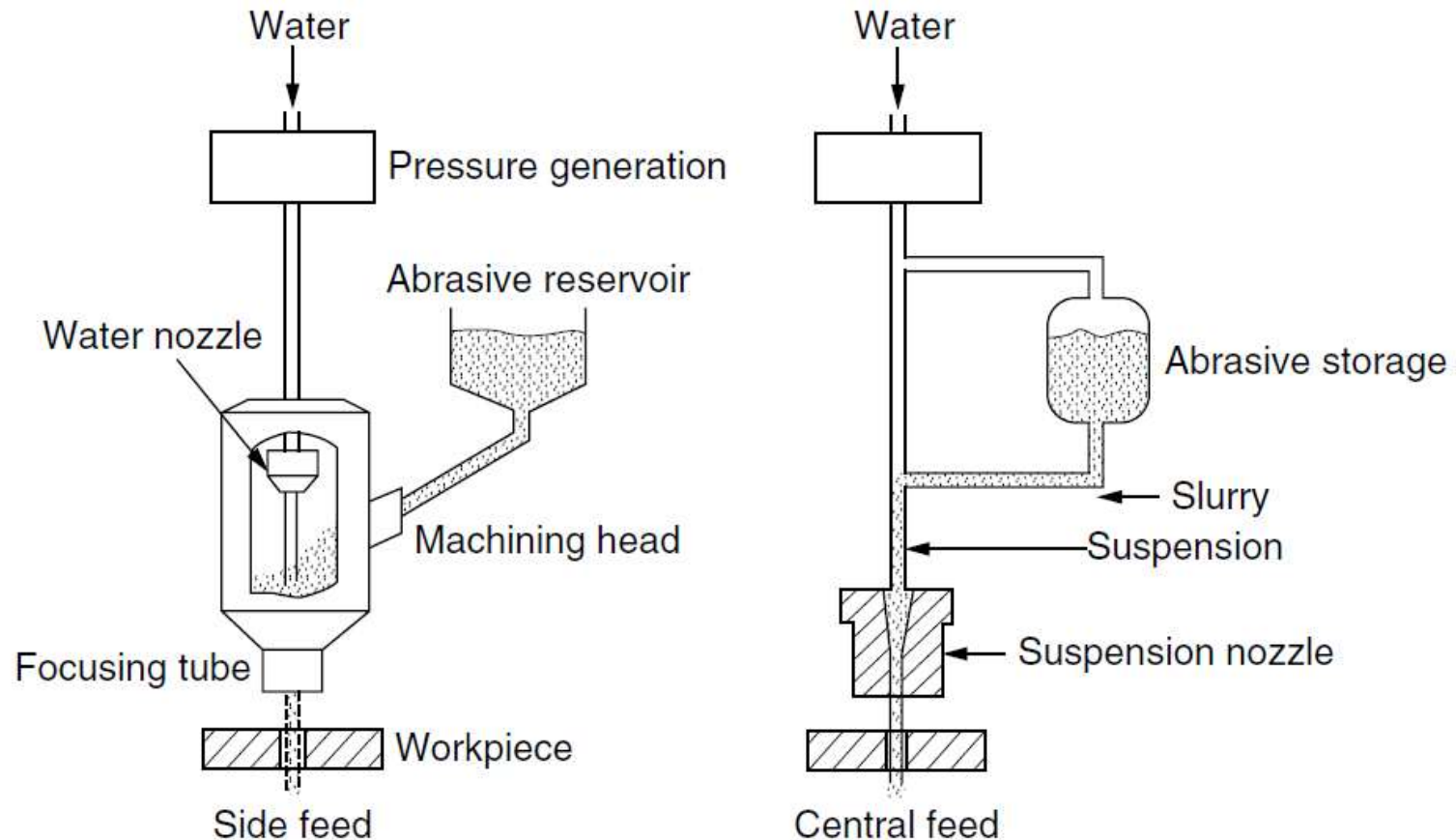

The machining system

- Water is pumped at a sufficiently high pressure, 200-400 MPa (2000-4000 bar) using intensifier technology.
- An intensifier works on the simple principle of pressure amplification using hydraulic cylinders of different cross-sections.
- When water at such pressure is issued through a suitable orifice (generally of 0.2- 0.4 mm dia), the potential energy of water is converted into kinetic energy, yielding a high velocity jet (1000 m/s).
- Such high velocity water jet can machine thin sheets/foils of aluminium, leather, textile, frozen food etc.

Advantages

- It has multidirectional cutting capacity.
- No heat is produced.
- Cuts can be started at any location without the need for predrilled holes.
- Wetting of the workpiece material is minimal.
- There is no deflection to the rest of the workpiece.
- The burr produced is minimal.
- The tool does not wear and, therefore, does not need sharpening.

Advantages

- The process is environmentally safe.
- There is multiple head processing.
- Simple fixturing eliminates costly and complicated tooling, which reduces turnaround time and lowers the cost.
- Grinding and polishing are eliminated, reducing secondary operation costs.
- The narrow kerf allows tight nesting when multiple parts are cut from a single blank.
- It is ideal for roughing out material for near net shape.

Advantages

- It is ideal for laser reflective materials such as copper and aluminum.
- It allows for more accurate cutting of soft material.
- It cuts through very thick material such as 383 mm in titanium and 307 mm in Inconel.

Disadvantages

- Hourly rates are relatively high.
- It is not suitable for mass production because of high maintenance requirements.
- Very thick parts can not be cut with water jet cutting and still hold dimensional accuracy. If the part is too thick, the jet may dissipate some, and cause it to cut on a diagonal, or to have a wider cut at the bottom of the part than the top. It can also cause a rough wave pattern on the cut surface.

WATER JET LAG

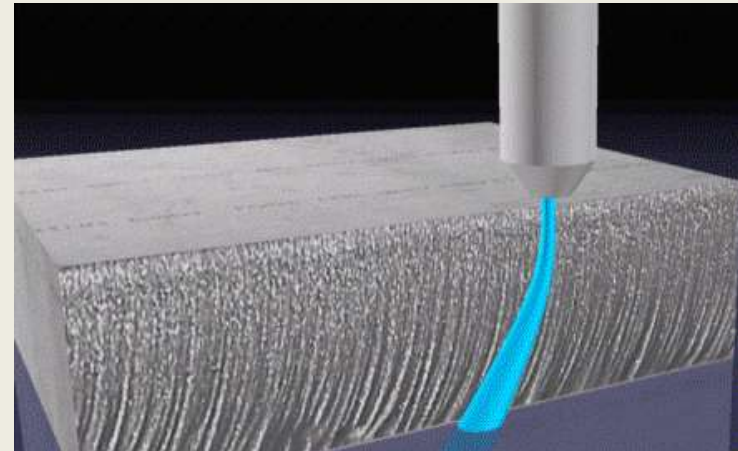

Abrasive Jet Machining

- In abrasive jet machining (AJM) a focused stream of abrasive grains of Al_2O_3 or SiC carried by high-pressure gas or air at a high velocity is made to impinge on the work surface through a nozzle of 0.3- to 0.5-mm diameter.
- The workpiece material is removed by the mechanical abrasion (MA) action of the high-velocity abrasive particles.
- It is typically used to cut, clean, peen, deburr, deflash, and etch glass, ceramics, or hard metals.

Machining system

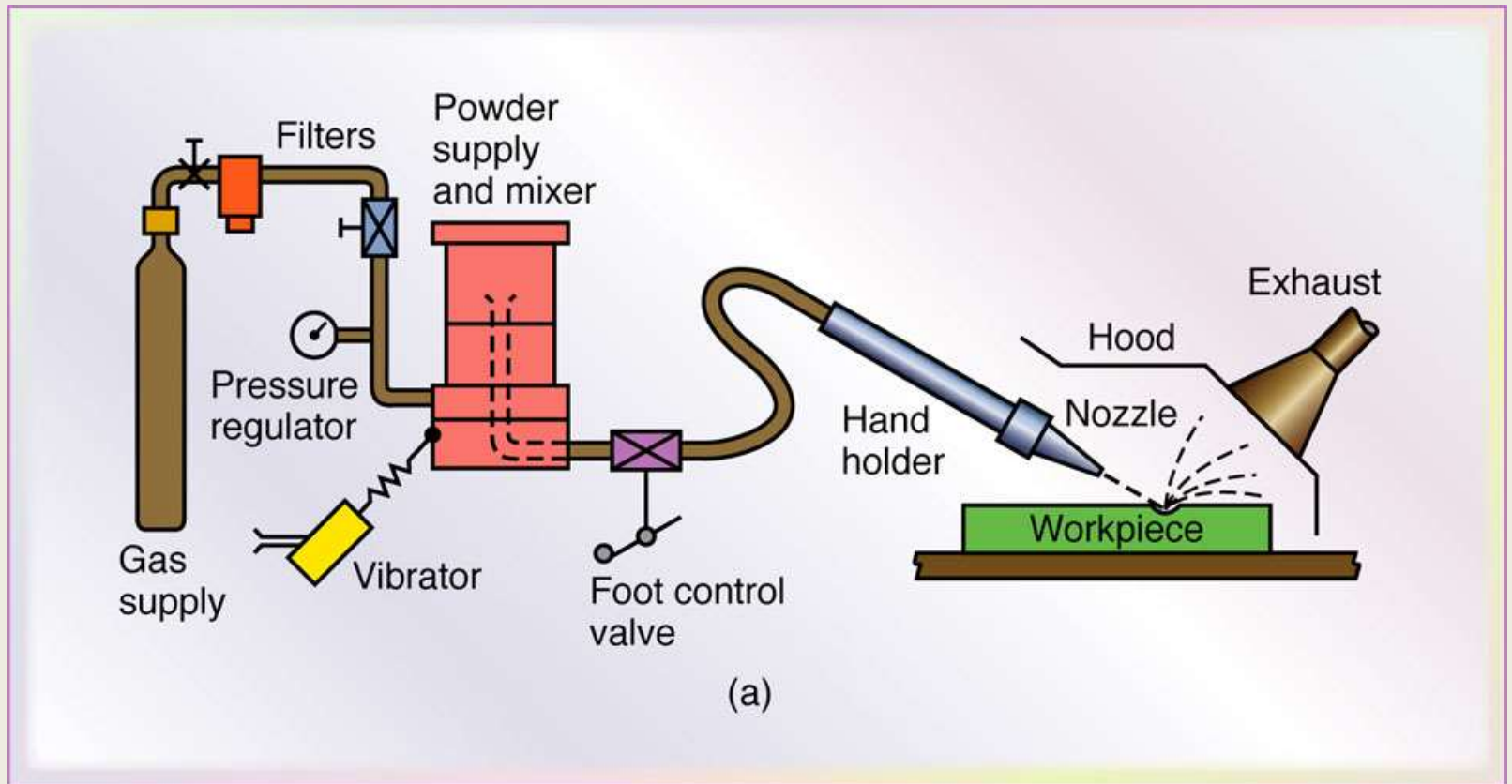

Machining system

1. Gas (nitrogen, CO₂, or air) is supplied under a pressure of 2 to 8 kg/cm².
2. After filtration and regulation, the gas is passed through a mixing chamber that contains abrasive particles and vibrates at 50 Hz.
3. As the abrasive particles impact the surface of the workpiece, it causes a small fracture at the surface of the workpiece. The material erosion occurs by the chipping action.
4. The erosion of material by chipping action is convenient in those materials that are hard and brittle.

Machining system

5. As the particles impact the surface of workpiece, it causes a small fracture and wear, which is carried away by the gas along with the abrasive particles.
6. The abrasive particles once used, cannot be re-used as its shape changes partially and the workpiece material is also clogged with the abrasive particles during impingement and subsequent flushing by the carrier gas.
7. The nozzle standoff distance is 0.81 mm. The relative motion between the workpiece and the nozzle is manually or automatically controlled using cam drives.

Machining system/ abrasive

- Aluminum oxide (Al_2O_3) and silicon carbide powders are used for heavy cleaning, cutting, and deburring.
- Magnesium carbonate is recommended for use in light cleaning and etching, while sodium bicarbonate is used for fine cleaning and the cutting of soft materials.

Note:

- Oxygen should never be used because it causes a violent chemical reaction with workpiece chips or abrasives.
- Commercial-grade powders are not suitable because their sizes are not well classified.

Material removal rate

The material removal rate, cut accuracy, surface roughness, and nozzle wear are influenced by:

- Size and distance of the nozzle.
- composition, strength, size, and shape of abrasives;
- flow rate
- composition, pressure, and velocity of the carrier gas.

Applications

1. Drilling holes, cutting slots, cleaning hard surfaces, deburring, polishing, and radiusing
2. Machining intricate shapes or holes in sensitive, brittle, thin, or difficult-to-machine materials.
3. Insulation stripping and wire cleaning without affecting the conductor
4. Micro-deburring of hypodermic needles.
5. Frosting glass and trimming of circuit boards,
6. Removal of films and delicate cleaning of irregular surfaces because the abrasive stream is able to follow contours

Advantages

- It is best suited for machining brittle and heat-sensitive materials like glass, quartz. *Because AJM is a cool machining process.*
- Used for machining superalloys and refractory materials.
- It is not reactive with any workpiece material.
- No tool changes are required.
- Intricate parts of sharp corners can be machined.
- The machined materials do not experience hardening.
- No initial hole is required for starting the operation as required by wire EDM.
- Material utilization is high.
- It can machine thin materials.

Disadvantages/ Limitations

- The removal rate is slow.
- Stray cutting can't be avoided (low accuracy of ± 0.1 mm).
- The tapering effect may occur especially when drilling in metals.
- The abrasive may get impeded in the work surface.
- Suitable dust-collecting systems should be provided.
- Soft materials can't be machined by the process.
- Silica dust may be a health hazard.
- Ordinary shop air should be filtered to remove moisture and oil.

Abrasive Waterjet Machining

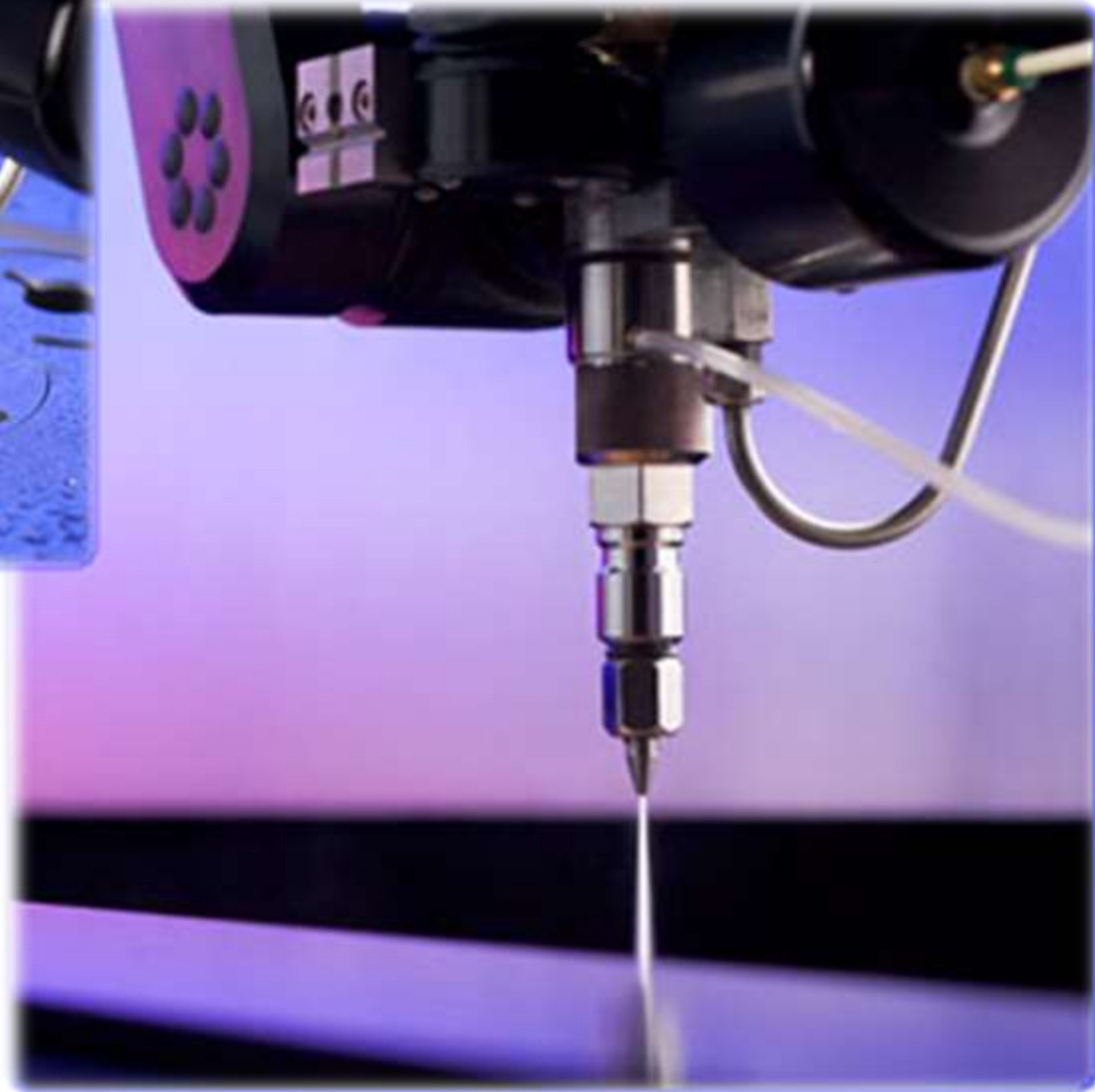

Dr. Ufaith H. Qadiri
Associate Professor
MREC Mechanical
Engg

Introduction to Waterjet

- Fastest growing machining process
- One of the most versatile machining processes
- Compliments other technologies such as milling, laser, EDM, plasma and routers
- True cold cutting process – no HAZ, mechanical stresses or operator and environmental hazards
- Not limited to machining – food industry applications

History

- Dr. Franz in 1950's first studied UHP water cutting for forestry and wood cutting (pure WJ)
- 1979 Dr. Mohamed Hashish added abrasive particles to increase cutting force and ability to cut hard materials including steel, glass and concrete (abrasive WJ)
- First commercial use was in automotive industry to cut glass in 1983
- Soon after, adopted by aerospace industry for cutting high-strength materials like Inconel, stainless steel and titanium as well as composites like carbon fiber

Pure WJ Cutting

- Pure cuts soft materials – corrugated cardboard, disposable diapers, tissue papers, automotive interiors
- Very thin stream (0.004-0.010 dia)
- Extremely detailed geometry
- Very little material loss due to cutting
- Can cut thick, soft, light materials like fiberglass insulation up to 24” thick or thin, fragile materials
- Very low cutting forces and simple fixturing
- Water jet erodes work at kerf line into small particles

Pure WJ Cutting cont.

- Water inlet pressure between 20k-60k psi
- Forced through hole in jewel 0.007-0.020" dia
- Sapphires, Rubies with 50-100 hour life
- Diamond with 800-2,000 hour life, but they are pricey

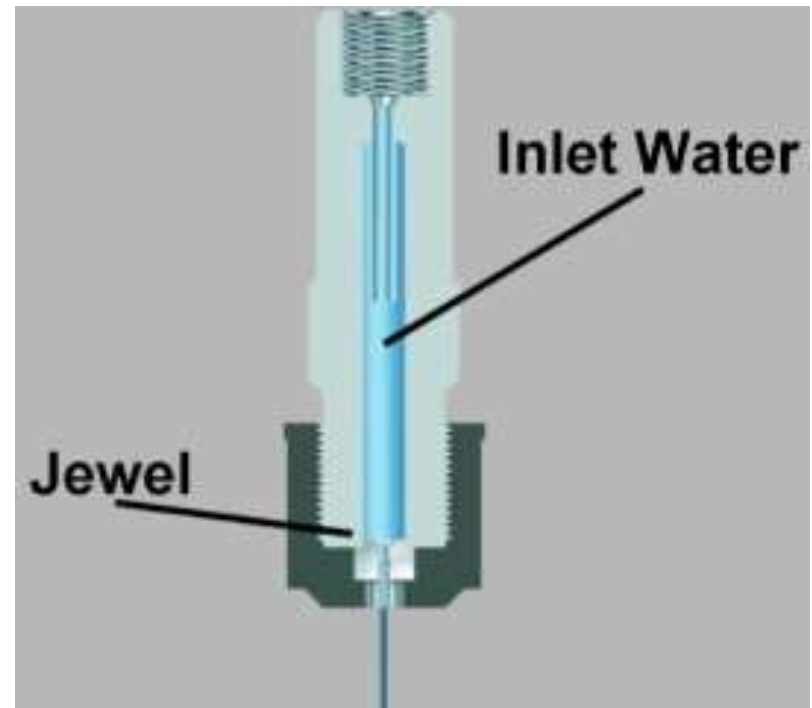

Abrasive WJ Cutting

- Used to cut much harder materials
- Water is not used directly to cut material as in Pure, instead water is used to accelerate abrasive particles which do the cutting
- 80-mesh garnet (sandpaper) is typically used though 50 and 120-mesh is also used
- Standoff distance between mixing tube and workpart is typically 0.010-0.200 – important to keep to a minimum to keep a good surface finish

Abrasive WJ Cutting cont.

- Evolution of mixing tube technology
- Standard Tungsten Carbide lasts 4-6 hours (not used much anymore)
- Premium Composite Carbide lasts 100-150 hours
- Consumables include water, abrasive, orifice and mixing tube

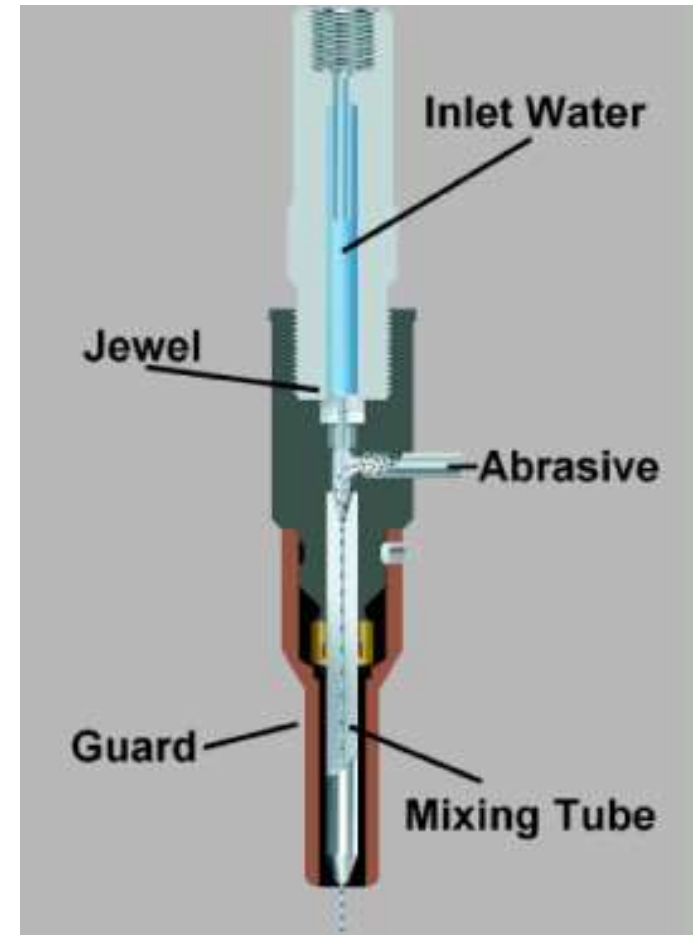

Tolerances

- Typically +/- 0.005 inch
- Machines usually have repeatability of 0.001 inch
- Comparatively traditional machining centers can hold tolerances of 0.0001 inch with similar repeatability
- WJ tolerance range is good for many applications where critical tolerances are not crucial to workpart design

Setup

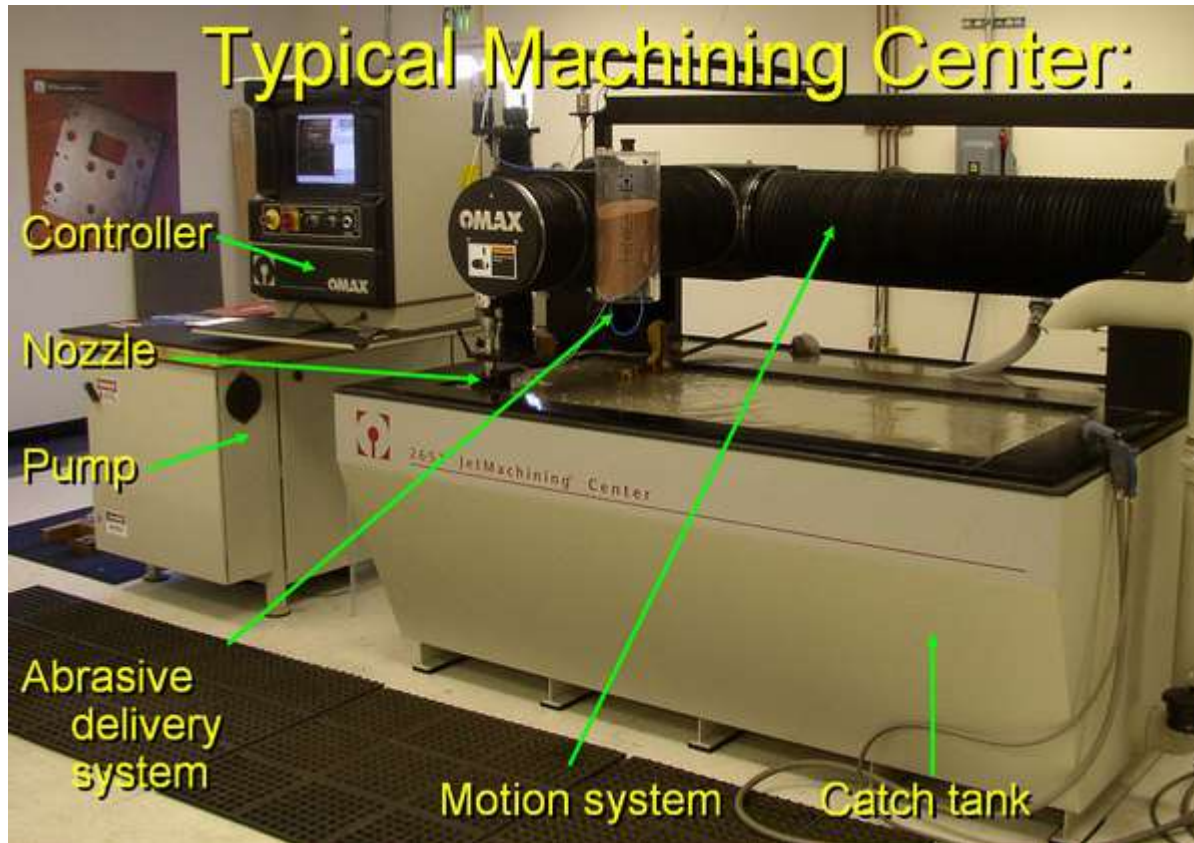

When is it Practical?

The cutter is commonly connected to a high-pressure water pump, where the water is then ejected from the nozzle, cutting through the material by spraying it with the jet of high-speed water.

It's practical to use it to cut any kind of material. In waterjet cutting, there is no heat generated. This is especially useful for cutting tool steel and other metals where excessive heat may change the properties of the material. Waterjet cutting does not leave a burr or a rough edge, and eliminates other machining operations such as finish sanding and grinding. It can be easily automated for production use.

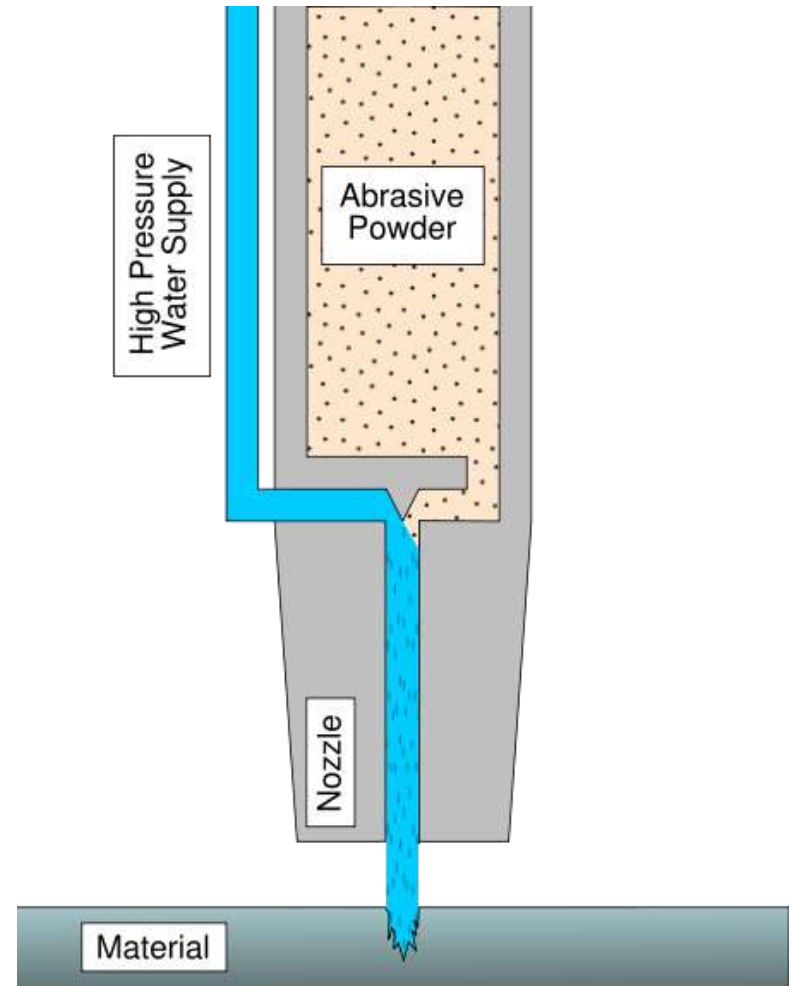

Advantages

- Cheaper than other processes.
- Cut virtually any material. (pre hardened steel, mild steel, copper, brass, aluminum; brittle materials like glass, ceramic, quartz, stone)
- Cut thin stuff, or thick stuff.
- Make all sorts of shapes with only one tool.
- No heat generated.
- Leaves a satin smooth finish, thus reducing secondary operations.
- Clean cutting process without gasses or oils.
- Modern systems are now very easy to learn.
- Are very safe.
- Machine stacks of thin parts all at once.



This part is shaped with waterjet using one tool. Slots, radii, holes, and profile in one 2 minute setup.

Advantages (continued)

- Unlike machining or grinding, waterjet cutting does not produce any dust or particles that are harmful if inhaled.
- The kerf width in waterjet cutting is very small, and very little material is wasted.
- Waterjet cutting can be easily used to produce prototype parts very efficiently. An operator can program the dimensions of the part into the control station, and the waterjet will cut the part out exactly as programmed. This is much faster and cheaper than drawing detailed prints of a part and then having a machinist cut the part out.
- Waterjets are much lighter than equivalent laser cutters, and when mounted on an automated robot. This reduces the problems of accelerating and decelerating the robot head, as well as taking less energy.



Get nice edge quality from different materials.

Disadvantages

- One of the main disadvantages of waterjet cutting is that a limited number of materials can be cut economically. While it is possible to cut tool steels, and other hard materials, the cutting rate has to be greatly reduced, and the time to cut a part can be very long. Because of this, waterjet cutting can be very costly and outweigh the advantages.
- Another disadvantage is that very thick parts can not be cut with waterjet cutting and still hold dimensional accuracy. If the part is too thick, the jet may dissipate some, and cause it to cut on a diagonal, or to have a wider cut at the bottom of the part than the top. It can also cause a rough wave pattern on the cut surface.

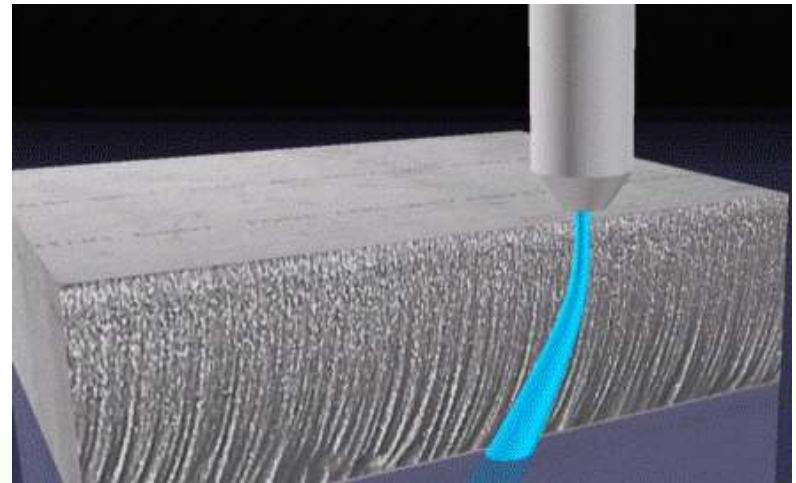

Waterjet lag

Disadvantages (continued)

- Taper is also a problem with waterjet cutting in very thick materials. Taper is when the jet exits the part at a different angle than it enters the part, and can cause dimensional inaccuracy. Decreasing the speed of the head may reduce this, although it can still be a problem.



Stream lag caused inside corner damage to this 1-in.-thick stainless steel part. The exit point of the stream lags behind the entrance point, causing irregularities on the inside corners of the part. The thicker the material is or the faster an operator tries to cut it, the greater the stream lag and the more pronounced the damage.

Waterjets vs. Lasers

- Abrasive waterjets can machine many materials that lasers cannot. (Reflective materials in particular, such as Aluminum and Copper).
- Uniformity of material is not very important to a waterjet.
- Waterjets do not heat your part. Thus there is no thermal distortion or hardening of the material.
- Precision abrasive jet machines can obtain about the same or higher tolerances than lasers (especially as thickness increases).
- Waterjets are safer.
- Maintenance on the abrasive jet nozzle is simpler than that of a laser, though probably just as frequent.



After laser cutting



After waterjet cutting

Waterjets vs. EDM

- Waterjets are much faster than EDM.
- Waterjets machine a wider variety of materials (virtually any material).
- Uniformity of material is not very important to a waterjet.
- Waterjets make their own pierce holes.
- Waterjets are capable of ignoring material aberrations that would cause wire EDM to lose flushing.
- Waterjets do not heat the surface of what they machine.
- Waterjets require less setup.
- Many EDM shops are also buying waterjets. Waterjets can be considered to be like super-fast EDM machines with less precision.



Waterjets are much faster than EDM.

Waterjets vs. Plasma

- Waterjets provide a nicer edge finish.
- Waterjets don't heat the part.
- Waterjets can cut virtually any material.
- Waterjets are more precise.
- Plasma is typically faster.
- Waterjets would make a great compliment to a plasma shop where more precision or higher quality is required, or for parts where heating is not good, or where there is a need to cut a wider range of materials.



After plasma cutting



After waterjet cutting

Waterjets vs. Other Processes

Flame Cutting:

Waterjets would make a great compliment to a flame cutting where more precision or higher quality is required, or for parts where heating is not good, or where there is a need to cut a wider range of materials.

Milling:

Waterjets are used a lot for complimenting or replacing milling operations. They are used for roughing out parts prior to milling, for replacing milling entirely, or for providing secondary machining on parts that just came off the mill. For this reason, many traditional machine shops are adding waterjet capability to provide a competitive edge.

Punch Press:

Some stamping houses are using waterjets for fast turn-around, or for low quantity or prototyping work. Waterjets make a great complimentary tool for punch presses and the like because they offer a wider range of capability for similar parts.

Future of Waterjet

- Drilling wells
- Drilling for oil
- Radial tunnels

Advanced Technology



Practical Applications

- Edge finishing
- Radiusing
- De-burring
- Polishing

Conclusion

- Relatively new technology has caught on quickly and is replacing century-old methods for manufacturing
- Used not only in typical machining applications, but food and soft-goods industries
- As material and pump technology advances faster cutting rates, longer component life and tighter tolerances will be achievable
- Paves the way for new machining processes that embrace simplicity and have a small environmental impact

References

- www.flowcorp.com
- www.waterjets.org
- www.aqua-dynamics.co.uk

Q&A



Advanced Manufacturing Choices

Electrical Energy Based Removing
Techniques

Dr.Ufaith H Qadiri
Associate Prof.

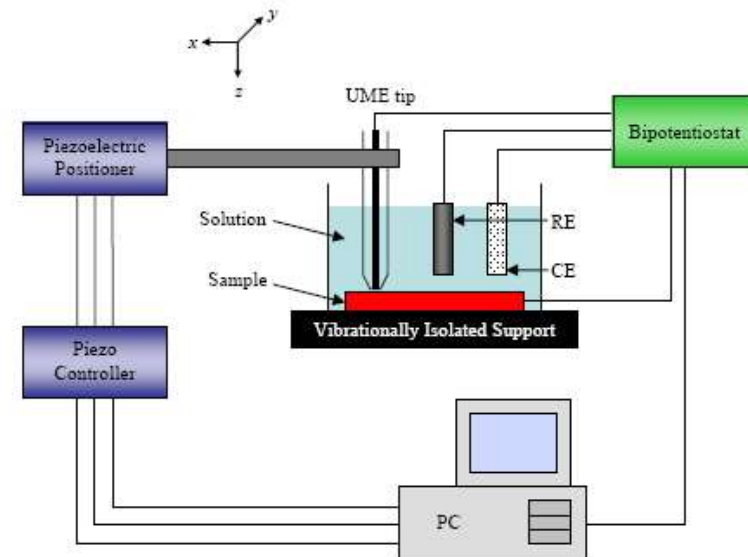

Electrical Energy Based Removing Techniques

- Electrochemical grinding (ECG)
- Electrochemical machining (ECM)

ECG and ECM

- In electrochemical material removal an electrical field in an electrolyte destroys the atomic bonds of the material.
- Under electrochemical removal techniques we will review electrochemical grinding (ECG) and electrochemical machining (ECM). The latter includes micro-electrochemical machining (μ -ECM), electrochemical jet etching, laser-assisted electrochemical jet micromachining and scanning electrochemical microscope machining (SECMM).

ECG and ECM

- The physics - an electrode and work piece (conductor) are placed in an electrolyte, and a potential/ voltage is applied. On the anode (+) side the metal molecules ionize (lose electrons) break free of the work piece, and travel through the electrolyte to the other electrode (a cathode; has a - charge; a surplus of electrons).
- Faraday's law states that:

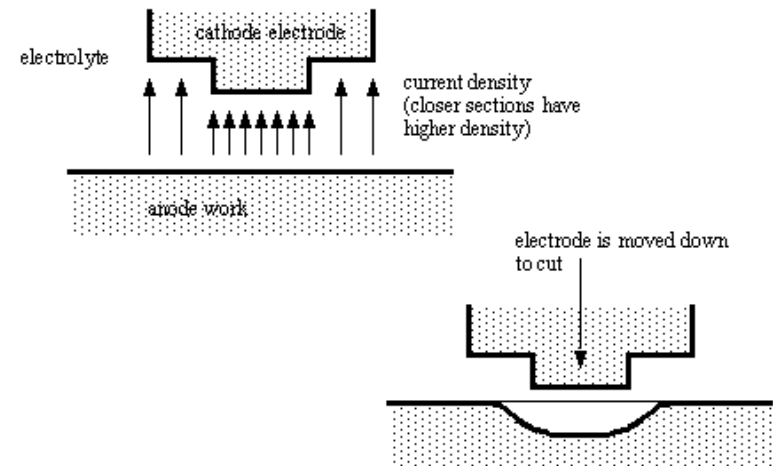

$$m = \frac{It\varepsilon}{F}$$

m = weight (g) of a material

I = current (A)

t = time (sec)

ε = gram equivalent weight of the material

F = constant of proportionality - Faraday (96,500 coulombs)

ECG and ECM

- Nomenclature of an electrochemical cell
- Scanning electrochemical microscope (SECM).

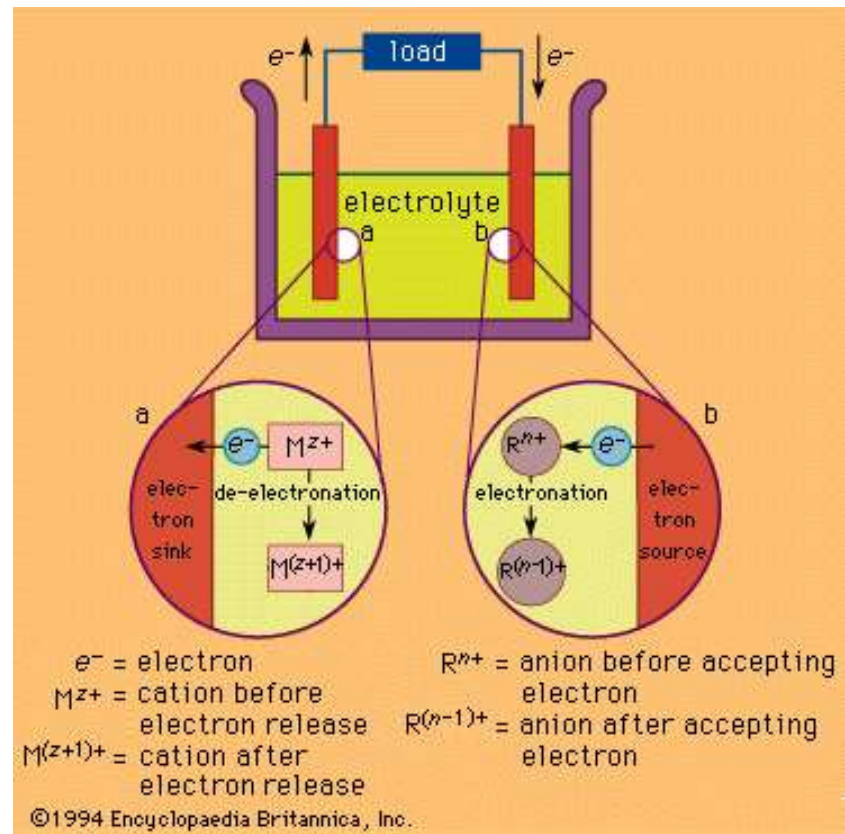
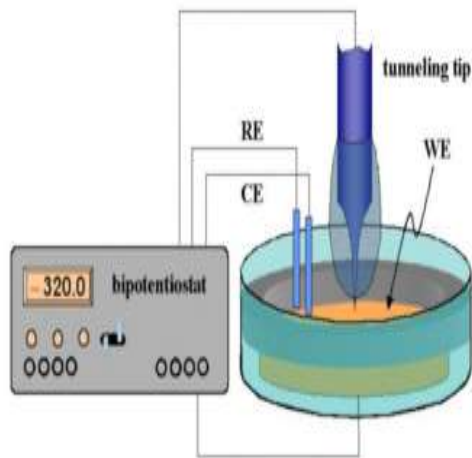

ECG

- Grinding usually constitutes a mechanical machining process that removes small amounts of material from a metallic work piece in the form of tiny chips through the contact of small, hard, sharp, nonmetallic particles often embedded in a grinding wheel.
- In electrochemical grinding (ECG), the abrasive action of an electrically conductive wheel, the cathode, accounts only for 10% of the metal removal, the remainder is electrochemical.



ECG

- Electrochemical grinding (ECG) is an electrolytic material-removal process involving a negatively charged abrasive grinding wheel, a conductive fluid (electrolyte), and a positively charged work piece.
- Work piece material corrodes into the electrolyte solution. ECG is similar to electrochemical machining except that the cathode is a specially constructed grinding wheel instead of a tool shaped like the contour to be machined.

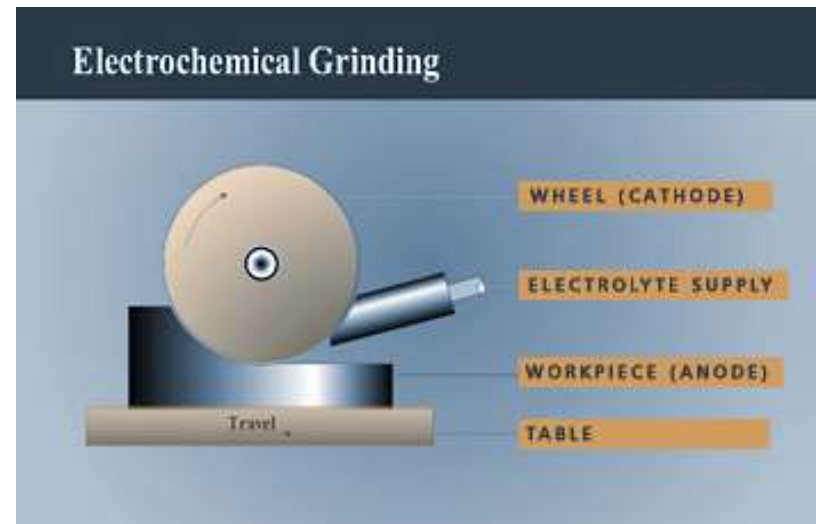

ECG Parameters

- Power requirements: In ECG operations, d-c power is used, usually at a potential of 4-14 V; current ranges from 50-3000 A.
- Current density: Generally, current densities range from 77 A/cm² when tungsten carbide is ground to 230 A/cm² when steels are ground.
- Metal removal rates: Faraday's laws closely apply to ECG in that metal removal rate is almost directly proportional to current density.
- A rule of thumb for estimating metal removal rate for most materials is 0.16 cm³/min for each 100 A of applied current. Usually, on materials harder than Rc 45, metal removal rates for ECG are up to 10 times faster than rates possible with conventional grinding.
- Wheel speed: In ECG operations, wheel speed is most often between 25-35 m/s. Wheel speed is important in that the wheel serves as an electrolyte pump and helps maintain an even flow of fluid between the wheel and work.
- Tolerances: With careful control of electrolyte temperature, specific gravity, and conductivity, it is possible to produce parts to within 0.005 mm.

ECG Advantages

- In operations in which ECG can be applied, it produces results far beyond those that conventional grinding methods can provide. In my cases it can reduce abrasive costs up to 90%.
- Also, because it is a cool process, ECG can be used to grind any electrically conductive material without damage to it from heat. In addition, this process can grind steel or alloy steel parts without generating any burr. Thus, the costly operation of subsequent deburring is automatically eliminated.
- ECG has found many applications in the aerospace, automotive instrumentation, textile, and medical manufacturing industries, among others. The process is most frequently used to grind hard, tough materials, because ECG is performed with significantly less wheel wear than conventional grinding. Surgical needles and thin-wall tubing are cut effectively due to the low forces generated in the ECG process.



Conductive grinding wheels

ECG Advantages

- Improved wheel life
- Burr free
- No work hardening
- Stress free
- Better finish
- No cracking
- Less frequent wheel dressing
- No metallurgical damage from heat
- Faster for tough materials
- No wheel loading or glazing
- More precise tolerances



ECM

- Electrochemical machining (ECM) is an electrolytic material removal process involving a negatively charged shaped electrode (cathode), a conductive fluid (electrolyte), and a conductive workpiece (anode).
- ECM is characterized as "reverse electroplating." The tool must be properly shaped, and provision for waste removal must be made.

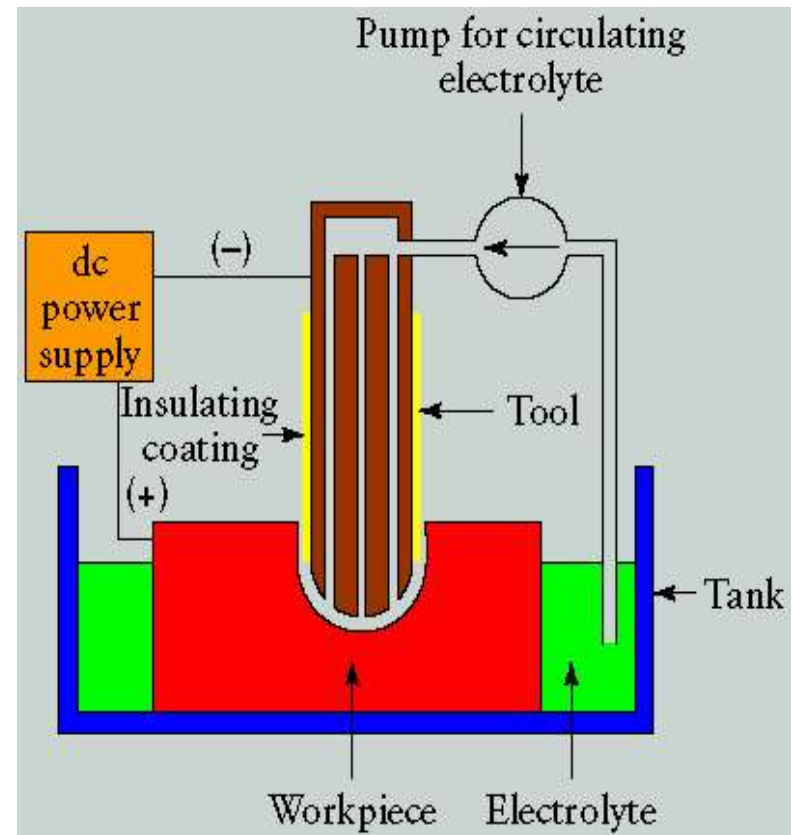

ECM

- Electrochemical machining (ECM) has been developed initially to machine these hard to machine alloys, although any metal can so be machined.
- ECM is an electrolytic process and its basis is the phenomenon of electrolysis, whose laws were established by Faraday in 1833.
- The first significant developments occurred in the 1950s, when ECM was investigated as a method for shaping high strength alloys.
- As of the 1990s, ECM is employed in many ways, for example, by automotive, offshore petroleum, and medical engineering industries, as well as by aerospace firms, which are its principal user.



ECM

- The tool is typically made of copper, brass, or stainless steel, while the most commonly used electrolyte is a concentrated solution of inorganic salts, such as sodium chloride, and the direct current power source is low voltage and high amperage.
- In the ECM process, the dc power source charges the workpiece positively and charges the tool negatively. As the machine slowly brings the tool and workpiece close together, perhaps to within 0.010 of an inch, the power and electrolyte flow are turned on. Electrons flow across the narrow gap from negative to positive, dissolving the workpiece into the shape as the tool advances into it. The recirculating electrolytic fluid carries away the dissolved material as a metal hydroxide.



ECM

- Electrochemical machining (ECM) historically followed ECG.
- In ECM one employs a cathode electrode shaped to provide the complementary structure in an anode work piece.
- A highly conductive electrolyte stream separates the cutting tool from the work piece, and metal removal is accomplished by passing a dc current of up to $100\text{A}/\text{cm}^2$ through the salt solution cell. As the cathode tool approaches the anode work piece it erodes its complementary shape in it. Thus complex shapes may be made from a material such as soft copper and used to produce negative duplicates of it. The process is also called electrochemical sinking.
- The pressurized electrolyte (concentrated solutions of inorganic salts such as sodium chloride, potassium chloride, and sodium nitrate) passes at high speed (10 to 60 m/s) through the gap (about 0.1 to 0.6 mm) between the work piece and the tool to prevent metal ions from plating onto the cathode tool and to remove the heat that is generated as a result of the high current flow.

ECM

- The cathode is advanced into the anode work piece at a rate matching the dissolution rate, which is between 0.5 and 10 mm/min when applying current densities of 10 to 100 A/cm². The supply voltage commonly used in ECM ranges from 5 to 20 V, the lower values being used for finish machining (creating of a final smooth surface) and the higher voltages for rough machining. The rate of material removal is the same for hard or soft materials, and surface finishes are between 0.3 and 1 μm. These cutting speeds and surface finishes are comparable to those of EDM.
- The cathode tool must have these four characteristics: be machinable, rigid (high Young's modulus), be a good conductor and have good corrosion resistance. The three most common cathode materials used are copper, brass, and stainless steel.
- Because there is no actual contact between the tool and the work, the tool does not have to be harder than the work, as in traditional machining methods. Hence, this is one of the few ways to machine very hard material; another is spark-discharge machining.

ECM: Advantages

- Components are not subject to either thermal or mechanical stress.
- There is no tool wear in ECM.
- Non-rigid and open work pieces can be machined easily as there is no contact between the tool and workpiece.
- Complex geometrical shapes can be machined repeatedly and accurately
- ECM is a time saving process when compared with conventional machining
- During drilling, deep holes can be made or several holes at once.
- ECM deburring can debur difficult to access areas of parts.
- Fragile parts which cannot take more loads and also brittle material which tend to develop cracks during machining can be machined easily in ECM
- Surface finishes of 25 μ in. can be achieved in ECM

ECM

- We close off this section with a Table comparing EDM with ECM, using conventional mechanical machining
- In this Table we list metal removal rates (MRR), tolerance, surface finish and damage depth, and required power.

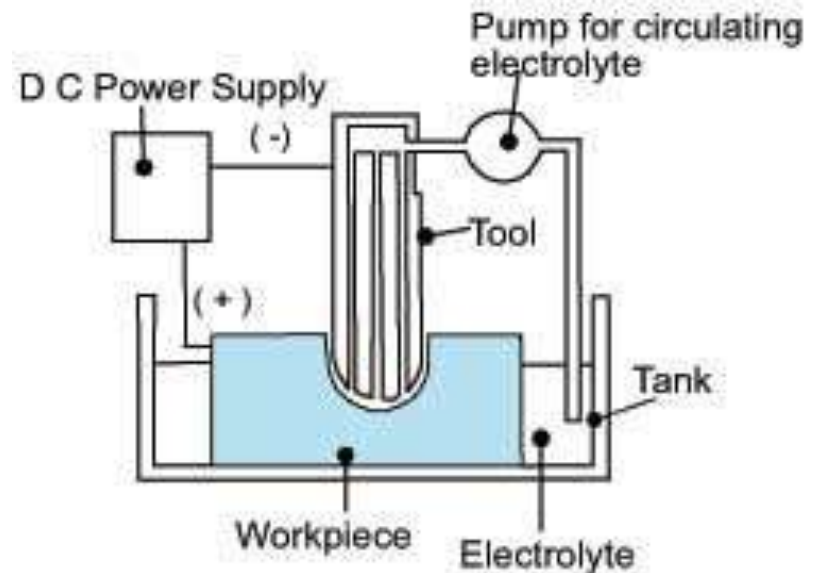

Electro-chemical Machining

ECM

TABLE Machining Characteristics of EDM and ECM

PROCESS	MRR mm³/min	TOLERANCE micron	SURFACE FINISH micron	DAMAGE DEPTH micron	POWER watts
ECM	15,000	50	0.1-2.5	5	100,000
EDM	800	15	0.2-1.2	125	2700
CNC	50,000	50	0.5-5	25	3000

Note: MRR = metal removal rate; tolerance = tolerance maintained; surface finish = surface finish required; damage depth = depth of surface damage; ECM = electrochemical machining; EDM = electro-discharge machining; CNC = computer numerical control machining.

ECM

- The metal removal rate by ECM is much higher than that of the EDM machining with a metal removal rate 0.3 that of CNC, whereas EDM is only a small fraction of the CNC material removal rate.
- Power requirements for ECM are comparatively high.
- The tolerance obtained by EDM and ECM is within the range of CNC machining, which means satisfactory dimensional accuracy can be maintained. All processes obtain satisfactory surface finishes. Depth of surface damage is very small for ECM, whereas it is very high in the case of EDM. For this reason, ECM can be employed for making dies and punches.
- Capital cost for ECM is very high when compared to conventional CNC machining and EDM has also a higher tooling cost than the other machining processes.

μ -ECM

- The application of ECM in thin film processing and in the fabrication of microstructures is referred to as electrochemical micromachining (EMM) or micro electrochemical machining μ -ECM.
- Different from ECM, the cathode does not necessarily have the shape of the contour desired in the anode work piece. Three-dimensional shaping in EMM may involve maskless or through-mask material removal.
- The tool may also be connected to a CNC machine to produce even more complex shapes with a single tool as illustrated below.

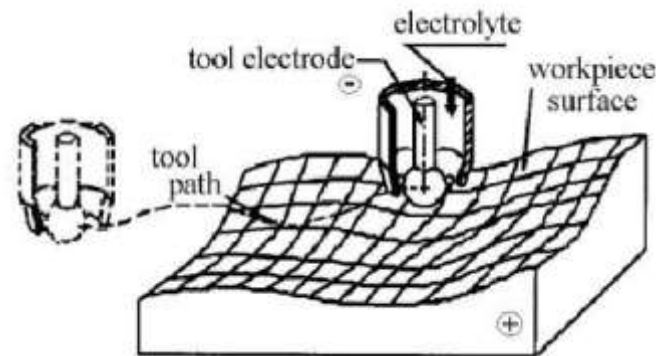

μ -ECM

- In conventional ECM the gap between cathode tool and anode work piece is typically about 150 microns, in micro ECM the gap is closer to 15-20 microns and feature sizes change from 150-200 microns to 15-20 microns as we move from the ECM to the μ -ECM domain.
- The major challenge in moving from the conventional ECM to the micro ECM domain is to control the size of the reaction region. Methods to accomplish this include:
 - A. Reduce the size of electrodes -Micro EDM is used
 - B. Shield the electrode -for stray currents
 - C. Gap control strategies
 - D. Use ultra short-pulsed voltages having time duration in the ranges of nanoseconds
- With electrochemical micromachining (EMM), most metals, alloys, and conducting ceramics of interest in the microelectronics and MEMS/NEMS industry can be anodically dissolved in a variety of neutral salt electrolytes such as sodium nitrate, sulfate, or chloride.

1/4/2022

Electrochemical Jet–Etching and Laser-Assisted Electrochemical Jet-Etching

- Thin film patterning by maskless EMM may be accomplished by highly localized material removal induced by the impingement of a fine electrolytic jet emanating from a small nozzle.
- An interesting variation on electrochemical jet etching is a combination of a fluid impinging jet and laser illumination
- In laser-enhanced electrochemical jet etching, properly chosen lasers, whose energy is not absorbed by the etching solution but is absorbed by the solid, cause local heating of the substrate (up to 150 ° C) resulting in highly increased etching.

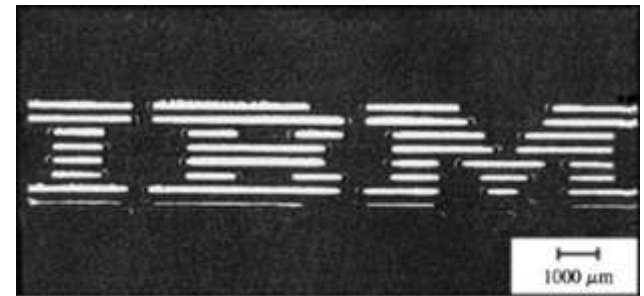

Electrochemical Jet–Etching and Laser-Assisted Electrochemical Jet-Etching

- The jet is used as a light pipe for the laser and at the same time as a means for the local high rate of supply of ions. For stainless steel, etch rates of $10\ \mu\text{m}/\text{sec}$ have been demonstrated using laser-enhanced electrochemical jet machining.
- Water jet etching is a mechanical process. Water jet guided laser etching without the electrochemical component is a purely thermal technique. In this important method, a fine waterjet again guides the laser beam, provides cooling for the work-piece and expels the molten material.

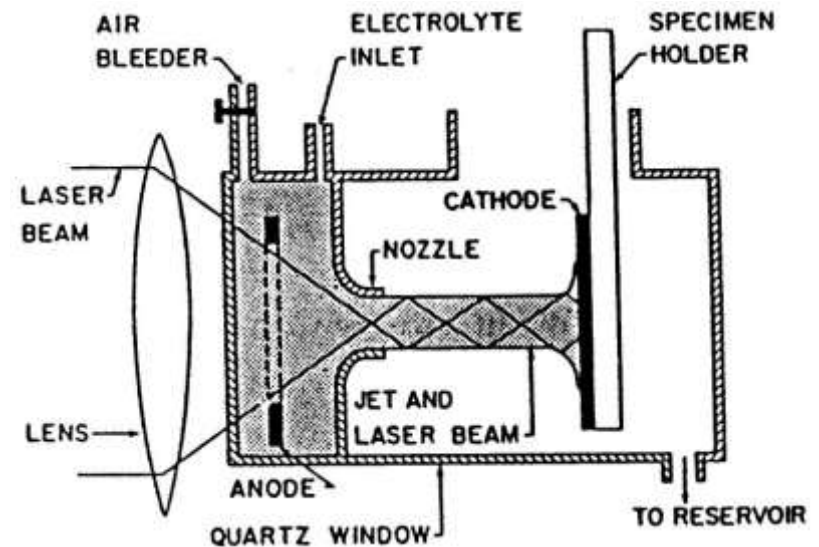

1/4/2022

Scanning Electrochemical Microscope (SECM)

- The scanning electrochemical microscope (SECM) is a scanned probe microscope (SPM) related to the familiar scanning tunneling (STM) and atomic force microscopes (AFM).
- All SPMs operate by scanning or "rastering" a small probe tip over the surface to be imaged. In SECM, imaging occurs in an electrolyte solution with an electrochemically active tip. In most cases, the SECM tip is an ultramicroelectrode (UME) and the tip signal is a Faradaic current from an electrochemical reaction at the surface.
- A scanning electrochemical microscope (SECM) can also be used for local etching and deposition with high resolution in the x, y and z dimensions, basically forming a high-resolution electrochemical machining setup.

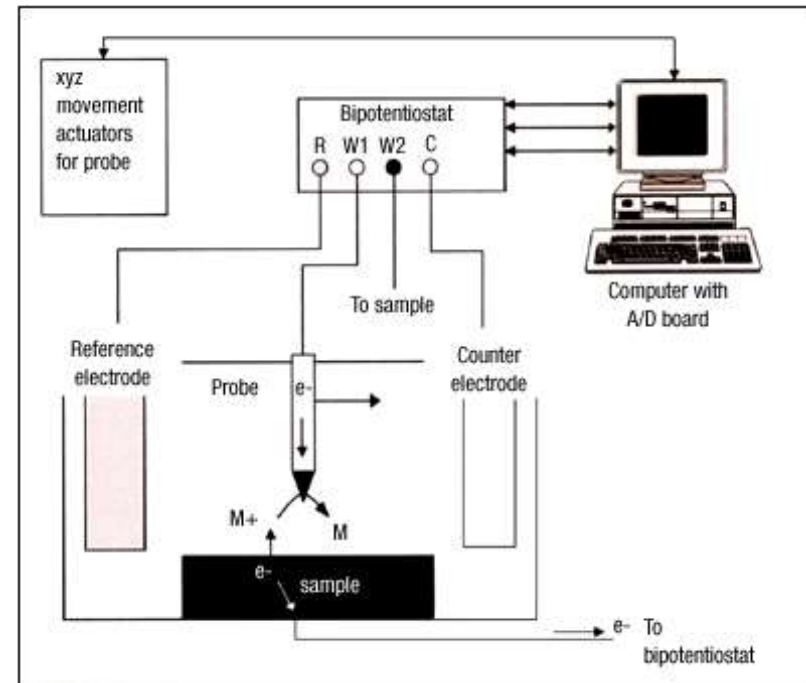

Advanced Manufacturing Choices

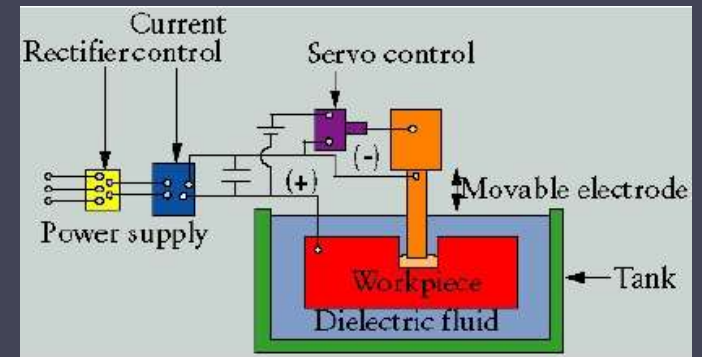

Thermal Energy Based
Removing Techniques

Dr. Ufaith Qadiri
Associate Professor

1/4/2022

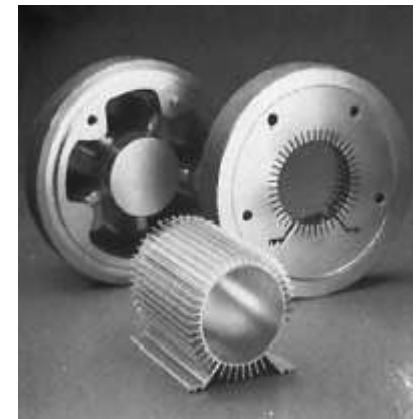

- Sinker electrical discharge machining (EDM) and wire EDM
- Laser beam machining
- Electron beam machining
- Plasma arc cutting
- What is a laser?

Thermal Removing Techniques

- In thermal removing processes, thermal energy, provided by a heat source, melts and/or vaporizes the volume of the material to be removed.
- Among thermal removal methods, **electrical discharge machining or EDM is the oldest** and most widely used. Electron-beam (EBM) and **laser beam machining (LBM)** are newer thermal techniques also widely accepted in industry today. Plasma-arc cutting using a plasma arc torch is mostly used for cutting relatively thick materials in the range of 3 to 75 mm and is less pertinent to most miniaturization science applications.
- In thermal removal processes, a heat-affected zone (HAZ), sometimes called a recast layer, is always left on the work-piece.
- In electron-beam, laser, and arc machining deposition as well as removal methods are available.

Electrical Discharge Machining - EDM

- In die-sinking EDM systems, the electrode (cutting tool) and work-piece are held by the machine tool. A power supply controls the electrical discharges and movement of the electrode in relation to the work-piece.
- During operation the work-piece is submerged in a bath of dielectric fluid (non-conducting). (Die-Sinking EDM is also called Sinker, ram EDM, Conventional, Plunge or Vertical EDM). SEE Youtube.

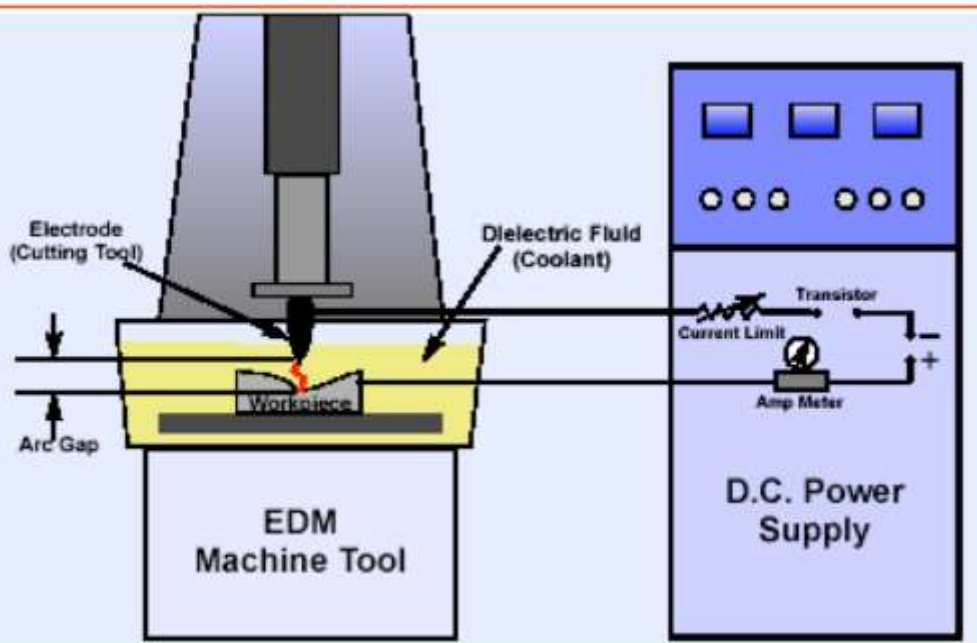

Electrical Discharge Machining - EDM

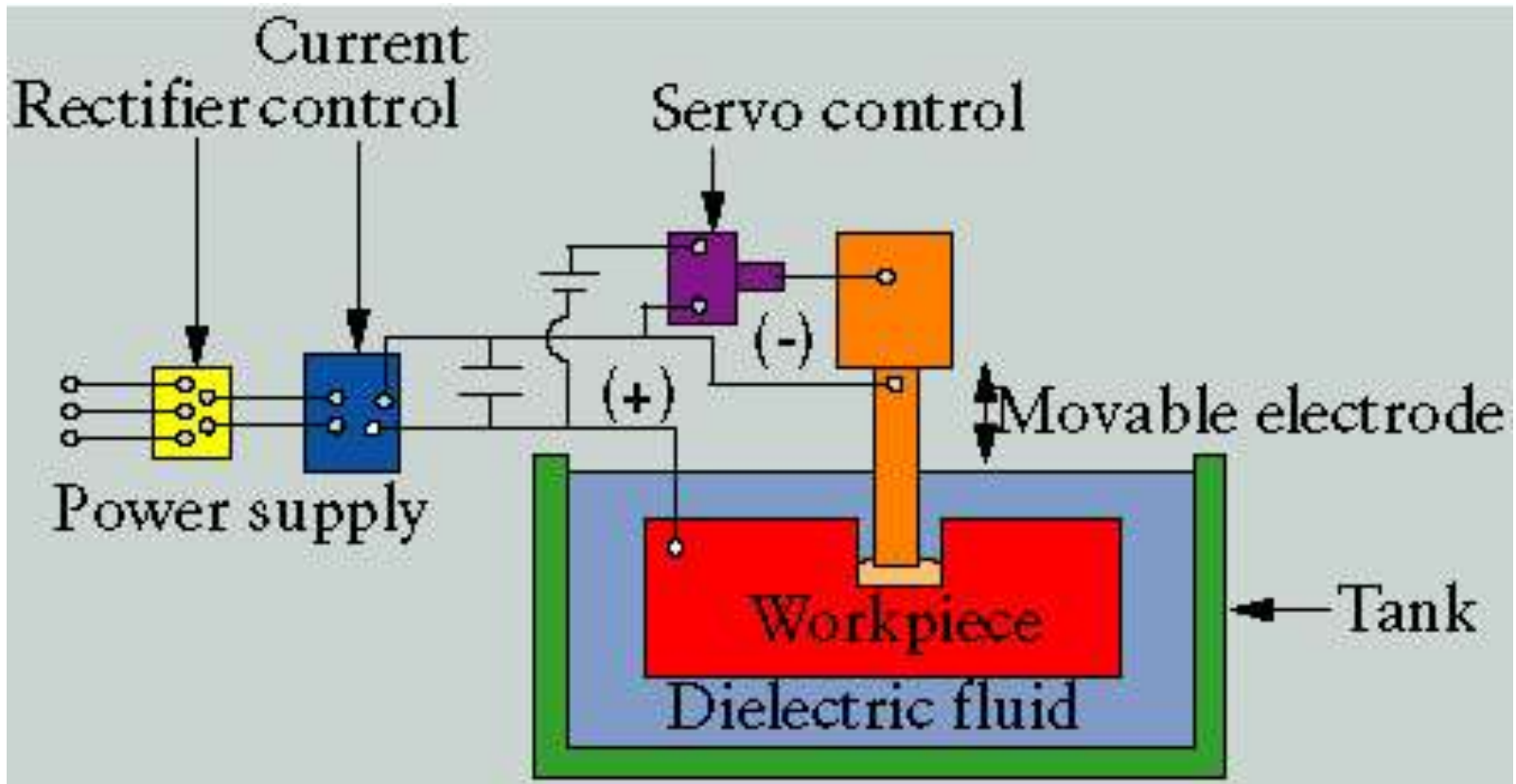

Schematic illustration of the electrical-discharge-machining process.
Based on erosion of metals by spark discharge. The cavity is formed by the shape of the electrode.

Electrical Discharge Machining - EDM

- During normal operation the electrode never touches the work-piece, but is separated by a small spark gap.
- The electrode (plunger) can be a complex shape, and can be moved in X, Y, and Z axes, as well as rotated, enabling more complex shapes with accuracy better than one mil. (this is called CNC plunger EDM)
- The spark discharges are pulsed on and off at a high frequency cycle and can repeat 250,000 times per second. Each discharge melts or vaporizes a small area of the work piece surface.
- Plunge EDM is best used in tool and die manufacturing, or for creating extremely accurate molds for injection-molding plastic parts.
- The amount of material removed from the work piece with each pulse is directly proportional to the energy it contains.

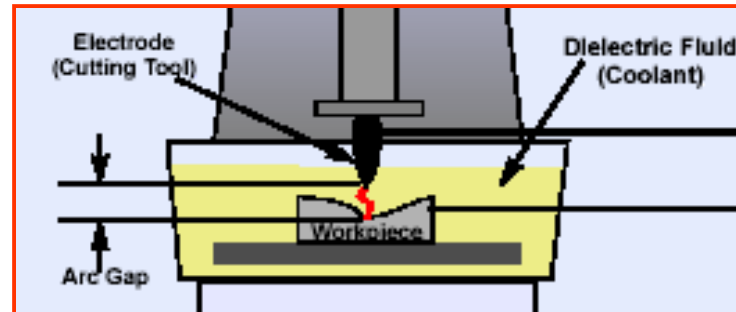

Electrical Discharge Machining - EDM

- The dielectric fluid in EDM performs the following functions:
 - It acts as an insulator until sufficiently high potential is reached .
 - Acts as a coolant medium and reduces the extremely high temp. in the arc gap.
 - More importantly, the dielectric fluid is pumped through the arc gap to flush away the eroded particles between the work-piece and the electrode which is critical to high metal removal rates and good machining conditions.
- A relatively soft graphite or metallic electrode can easily machine hardened tool steels or tungsten carbide. One of the many attractive benefits of using the EDM process.

Electrical Discharge Machining- EDM

- Stepped cavities produced with a square electrode by EDM. The workpiece moves in the two principal horizontal directions, and its motion is synchronized with the downward movement of the electrode to produce various cavities
- Also shown is a round electrode capable of producing round or elliptical cavities. Obviously, this is done under computer control (CNC plunger EDM).

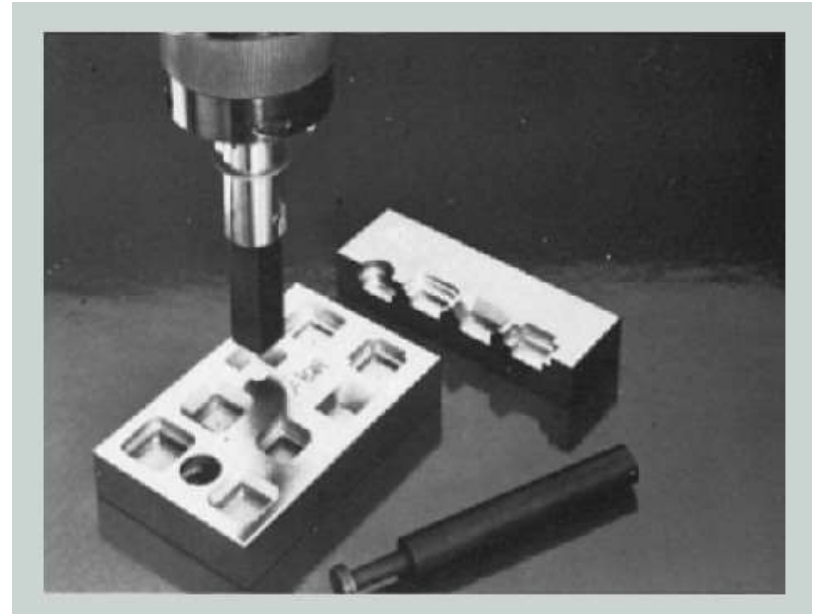

Electrical Discharge Machining- EDM

- Surface finish is affected by gap voltage, discharge current, and frequency
- The EDM process can be used on any material that is an electrical conductor
- The EDM process does not involve mechanical energy, therefore, materials with high hardness and strength can easily be machined.
- Applications include producing die cavity for large components, deep small holes, complicated internal cavities
- EDM is not a fast method; some jobs can take days to produce holes, so its use is limited to jobs that cannot easily be done in other ways (e.g. oblong slots or complex shapes, sometimes in very hard material).
- Note too the work must be conductive so it does not work on materials such as glass or ceramic, or most plastics.

Typical use	Hard, machining of brittle metals, tool making
Tool	Carbon, zinc, brass, copper, silver-tungsten or copper-tungsten
Dielectric medium	Distilled water (DI), petroleum oils, silicones, triethylene, glycol water mixtures
Aspect ratio of holes	As high as 100:1
Surface finish	1 to 3 μm but even 0.25 μm has been reported
Gap size/voltage	25 μm /80 V
Removal rate	0.001 to 0.1 cm^3/hr
Workpiece	Conductor

Electrical Discharge Machining- EDM

- When referring to micro electrical discharge machining (μ -EDM) one refers either to working with a small EDM machine (see Figure for a hand-held EDM at Panasonic) or to working with smaller than usual electrodes (in sinker EDM) or with thinner wires (in EDM-WC).



Batch Electrical Discharge Machining- EDM

- The use of microelectrode arrays enables one to use μ -EDM in batch mode as pioneered by Takahata
- Takahata employed the LIGA process to make microelectrode arrays.
- Structures made with this hybrid LIGA-EDM method are shown in the Figure on the right.
- C-MEMS as electrodes!

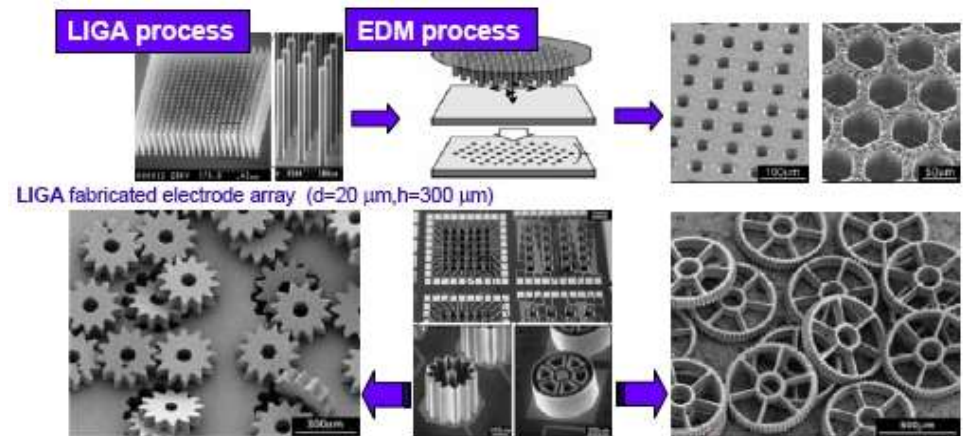

Wire Electrical Discharge Machining

- Electrical discharge machining wire cutting (EDM-WC) is a thermal mass-reducing process that uses a continuously moving wire to remove material by means of rapid controlled repetitive spark discharges.
- A dielectric fluid is used to flush the removed particles, regulate the discharge, and keep the wire and workpiece cool. The wire and workpiece must be electrically conductive.

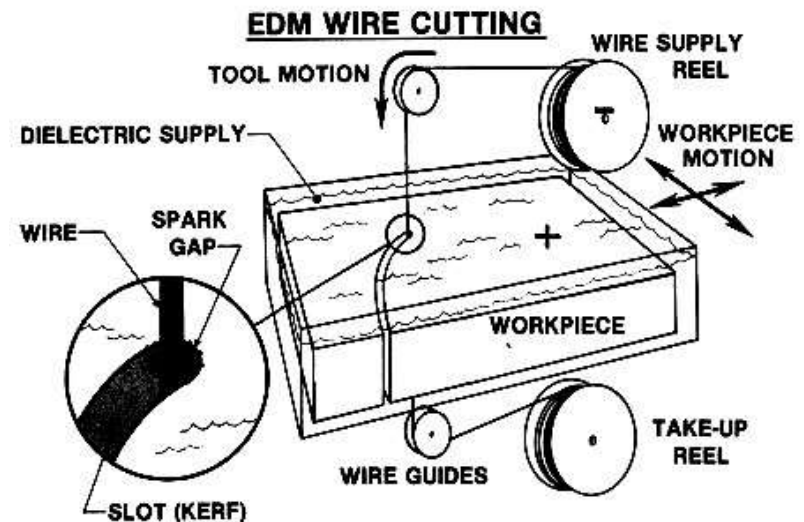

Wire Electrical Discharge Machining

- Schematic illustration of the wire EDM process. As much as 50 hours of machining can be performed with one reel of wire, which is then discarded.

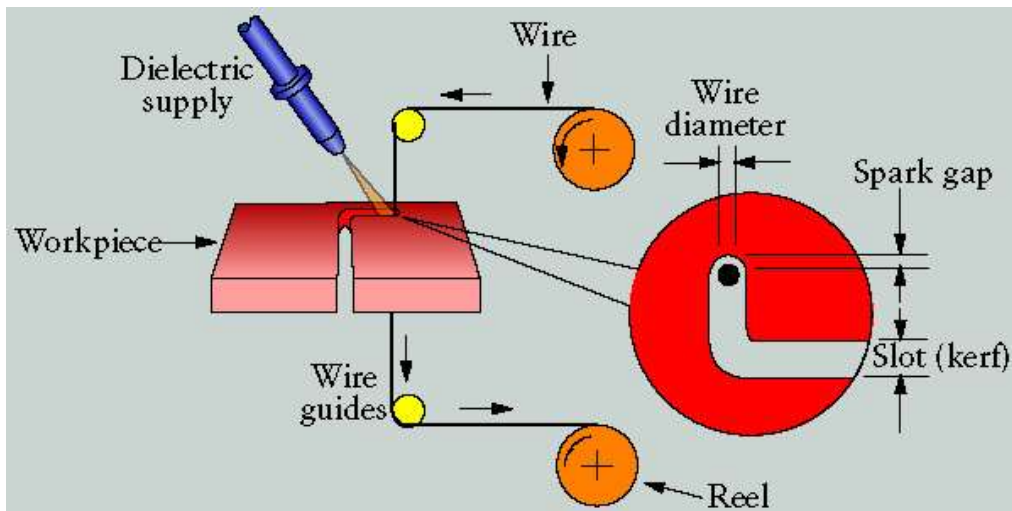

Typical EDM-WC products.

Wire Electrical Discharge Machining

- Utilizes a traveling wire that is advanced within arcing distance of the workpiece (0.001 in).
- Removes material by rapid, controlled, repetitive spark.
- Uses dielectric fluid to flush removed particles, control discharge, and cool wire and workpiece.
- Is performed on electrically conductive workpieces.
- Can produce complex three-dimensional shapes

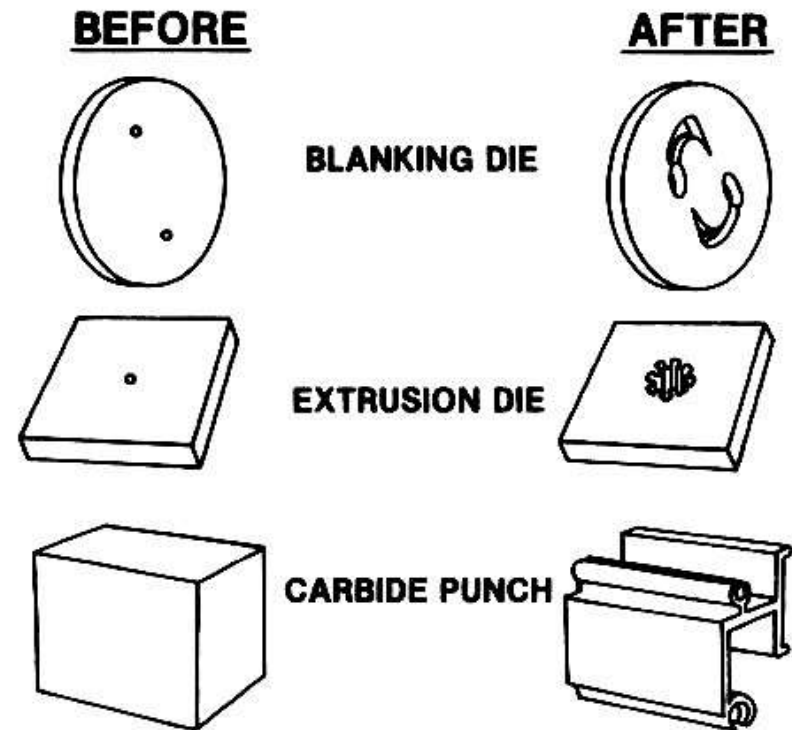

Wire Electrical Discharge Machining

- Numerically controlled wire EDM has revolutionized die making, particularly for plastic molders. Wire EDM is now common in tool-and-die shops. Shape accuracy in EDM-WC in a working environment with temperature variations of about 3°C is about $4\ \mu\text{m}$. If temperature control is within $\pm 1^{\circ}\text{C}$, the obtainable accuracy is closer to $1\ \mu\text{m}$.
- No burrs are generated and since no cutting forces are present, wire EDM is ideal for delicate parts.
- No tooling is required, so delivery times are short. Pieces over 16 in thick can be machined. Tools and parts are machined after heat treatment, so dimensional accuracy is held and not affected by heat treat distortion.

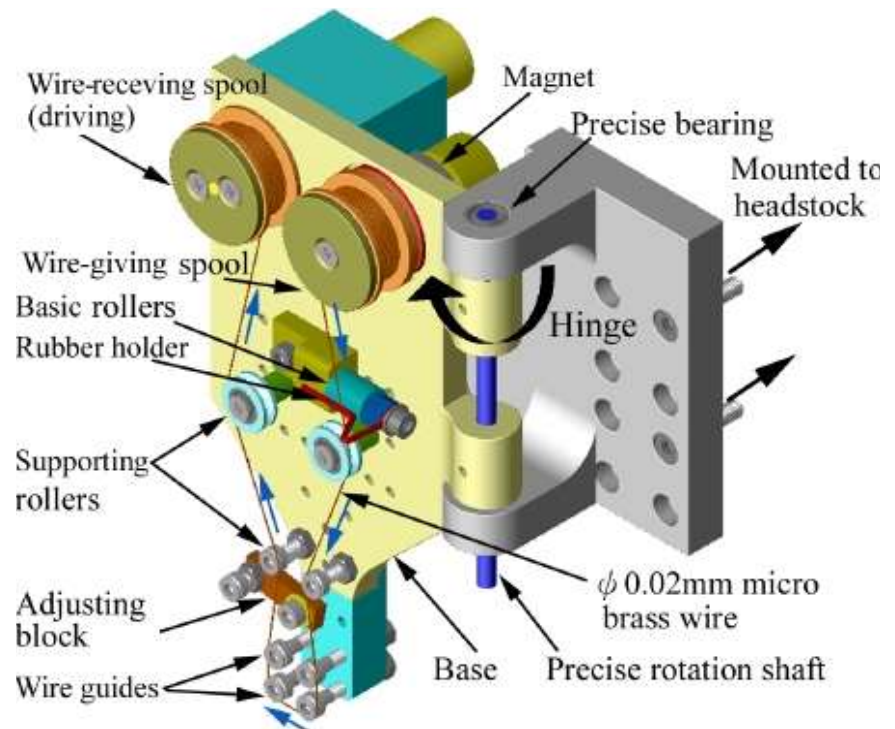

Wire Electrical Discharge Machining

- The vertical, horizontal and slanted cutting with the μ -EDM-WC tool has successfully fabricated complex features and parts.
- An example is the impressive Chinese pagoda (1.25 mm \times 1.75 mm) shown here where vertical and horizontal μ -EDM-WC cuts are illustrated

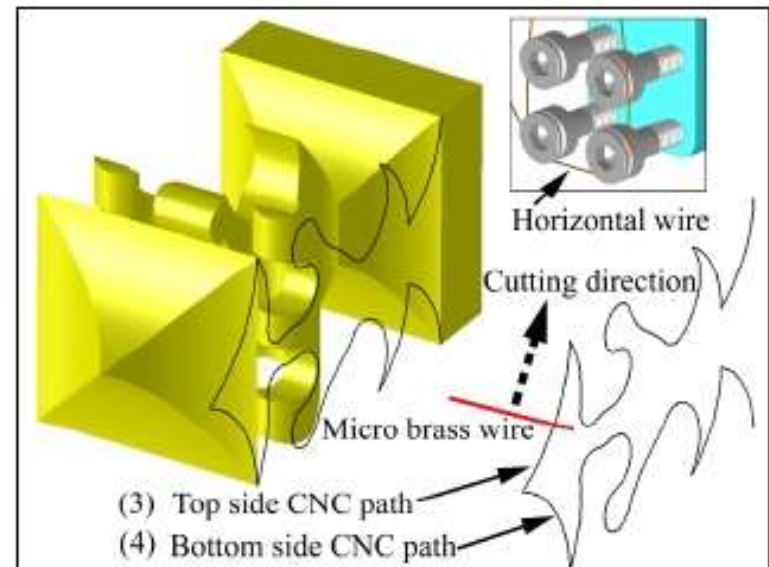
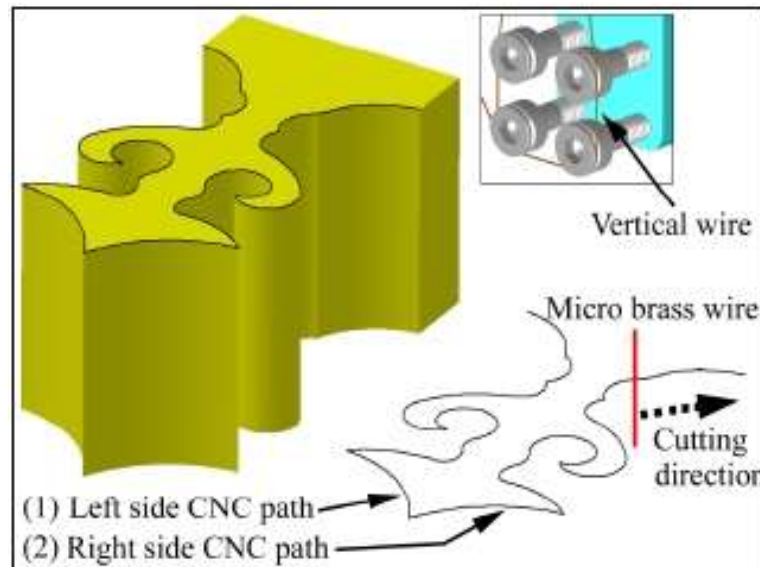

Laser Beam Machining

- The word laser stands for Light Amplification by Stimulated Emission of Radiation.
- Machining with laser beams, first introduced in the early 1970s, is now used routinely in many industries. Laser machining, with long or continuous wave (CW*), short, and ultra-short pulses, includes the following applications:
 - Heat treatment
 - Welding
 - Ablation or cutting of plastics, glasses, ceramics, semiconductors and metals
 - Material deposition–
 - Etching with chemical assist i.e., Laser Assisted Chemical Etching or LACE
 - Laser-enhanced jet plating and etching
 - Lithography
 - Surgery
 - Photo-polymerization (e.g., μ -stereolithography)

*In laser physics and engineering the term "continuous wave" or "CW" refers to a laser which produces a continuous output beam, sometimes referred to as 'free-running'.

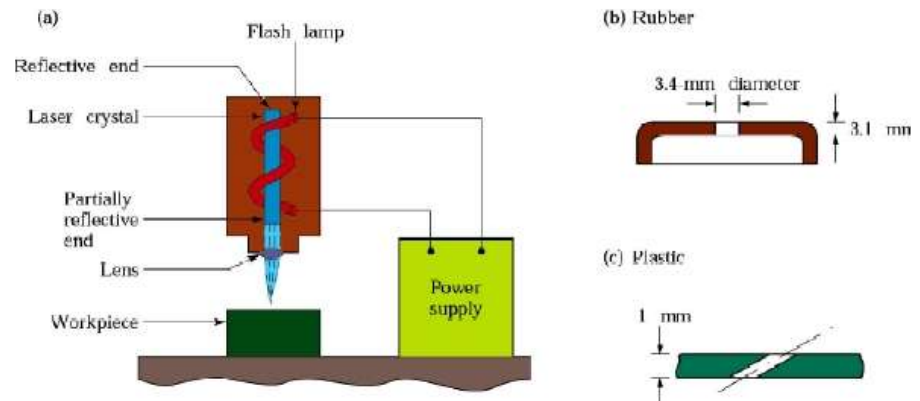

(a) Schematic illustration of the laser-beam machining process. (b) and (c) Examples of holes produced in non-metallic parts by LBM.

Nd: YAG : neodymium-doped yttrium aluminum garnet is a crystal that is used as a lasing medium for solid-state lasers. ...

Laser Beam Machining

APPLICATION	LASER TYPE
Cutting	
Metals	PCO ₂ ; CWCO ₂ ; Nd:YAG; ruby
Plastics	CWCO ₂
Ceramics	PCO ₂
Drilling	
Metals	PCO ₂ ; Nd:YAG; Nd:glass; ruby
Plastics	Excimer
Marking	
Metals	PCO ₂ ; Nd:YAG
Plastics	Excimer
Ceramics	Excimer
Surface treatment (metals)	CWCO ₂
Welding (metals)	PCO ₂ ; CWCO ₂ ; Nd:YAG; Nd:glass; ruby

Note: P = pulsed, CW = continuous wave.

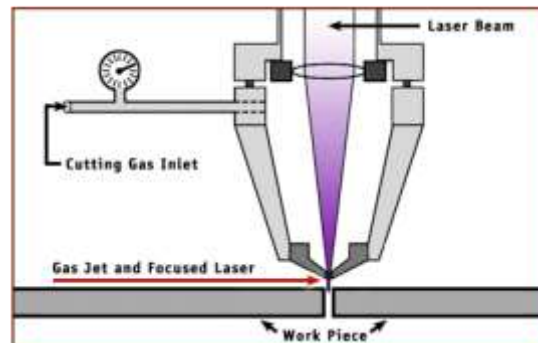
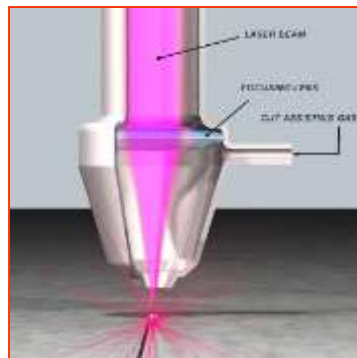

Gas is blown into the cut to clear away molten metals, or other materials in the cutting zone. In some cases, the gas jet can be chosen to react chemically with the workpiece to produce heat and accelerate the cutting speed (LACE)

Laser Beam Machining

- A laser machine consists of the laser, some mirrors or a fiber for beam guidance, focusing optics and a positioning system. The laser beam is focused onto the work-piece and can be moved relatively to it. The laser machining process is controlled by switching the laser on and off, changing the laser pulse energy and other laser parameters, and by positioning either the work-piece or the laser focus.
- Laser machining is localized, non-contact machining and is almost reaction-force free. Photon energy is absorbed by target material in the form of thermal energy or photochemical energy. Material is removed by melting and blown away (long pulsed and continuous-wave lasers), or by direct vaporization/ablation (ultra-short pulsed lasers). Any material that can properly absorb the laser irradiation can be laser machined. The spectrum of laser machinable materials includes hard and brittle materials as well as soft materials. The very high intensities of ultra-short pulsed lasers enable absorption even in transparent materials.

Laser Beam Machining- Graduate Only

- Pulsed lasers (beam waist):

$$I(r) = I_0 \times e^{-\frac{2r^2}{w^2}}$$

w ~ “beam waist” or 1/e² radius

~ **be careful, 1/e radius is used for calculating electric field**

~ *μm* to mm

~ 20 to 40 *μm* for Nd:YAG harmonic lasers w optics

*I*₀ ~ axial intensity

w ~ beam waist (i.e. 1/e² radius)

At *r* = *w*, the *I*(*r*) is at 1/e² (13.5%) of the axial intensity, *I*₀.

Laser Beam Machining- Graduate Only

- For a given beam, I_0 will be at a maximum in the focal plane where $w = w_0$, the minimum beam waist.

$$P_{total} = \int_0^{\infty} I(r) dA = \int_0^{\infty} I_0 \times e^{-\frac{2r^2}{w^2}} 2\pi r dr$$

$$P_{total} = \frac{w^2 \times I_0 \times \rho}{2}$$

$$\therefore I_0 = \frac{2 \times P_{total}}{\rho \times w^2}$$

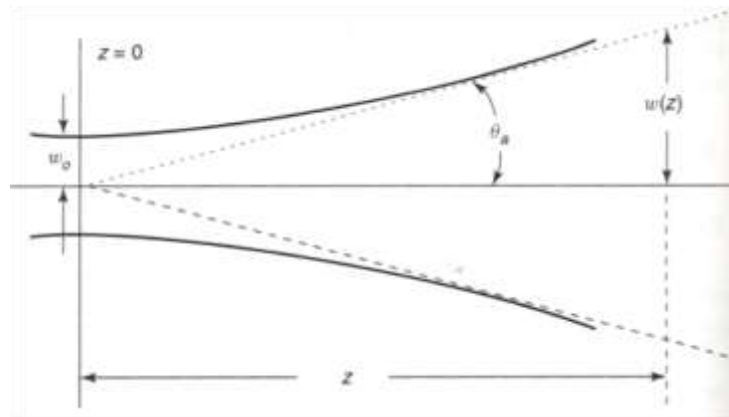

Laser Beam Machining- Graduate Only

$w_0 = \text{min. waist; } = w_f$
waist in the focal plane
 $z_R \sim \text{Rayleigh range (or}$
confocal parameter)

$$z_R = \frac{\pi \cdot n \cdot w_0^2}{\lambda_0}$$

$n \sim \text{index of refraction}$
(approx. 1 for air)
 $\lambda_0 \sim \text{free space}$
wavelength

$$w^2 = w_0^2 \left[1 + \left(\frac{z}{z_R} \right)^2 \right]$$

- The parameter $w(z)$ approaches a straight line for $z \gg z_R$
- The angle between this straight line and the central axis of the beam is called the divergence of the beam. It is given by

$$\theta \simeq \frac{\lambda}{\pi w_0} \quad (\theta \text{ in radians.})$$

Laser Beam Machining- GraduateOnly

At $z = 0$, the minimum beam waist, w_0 (w_f), is:

$$w_0 = w_f = \frac{l_0 \times f}{\rho \times n \times w_{in}}$$

where

w_f – $1/e^2$ beam waist in the focal plane

f – focal length of lens

w_{in} – beam waist into the lens (at $z = -f$)

n – index of refraction (approx. 1 for air)

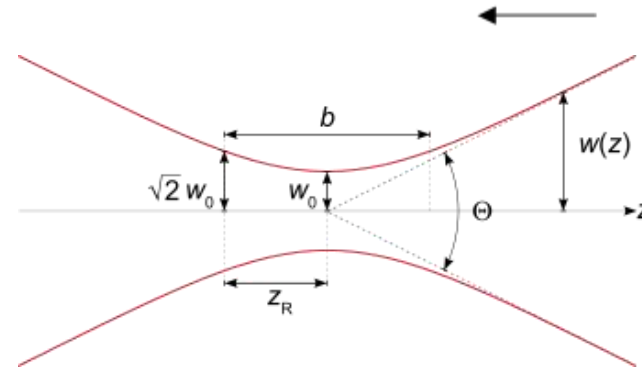

Laser Beam Machining- Graduate Only.

DOF=2. Z_R

$$w^2 = w_0^2 \left[1 + \left(\frac{z}{Z_R} \right)^2 \right]$$

The distance between these two points is called the *confocal parameter* or *depth of focus of the beam*:

At $z = \pm z_R$:

$$w = \sqrt{2} \times w_f = \sqrt{2} \times w_0$$

so I_0 is decreased by 2X.

$$I_0 = \frac{2 \times P_{total}}{\left(\sqrt{2} \times w_f \right)^2 \times \rho}$$

Laser Beam Machining

- If a "perfect" lens (no spherical aberration) is used to focus a collimated laser beam, the minimum spot size radius or the focused waist (w_0) is limited by diffraction only and is given by (f is the focal length of the lens) :

$$w_0 = \frac{f}{\rho D_{\text{lens}}}$$

- With d_0 the diameter of the focus ($= 2w_0$) and with the diameter of the lens $D_{\text{lens}} = 2w_{\text{lens}}$ (or the diameter of the laser beam at the lens –whatever is the smallest) we obtain:

$$d_0 = \frac{4/f}{\rho D_{\text{lens}}} = \frac{1.27/f}{D_{\text{lens}}}$$

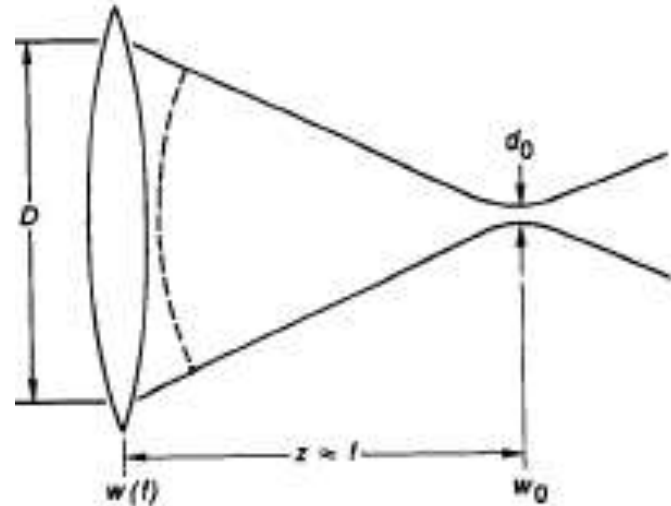

Laser Beam Machining

- Thus, the principal way of increasing the resolution in laser machining, as in photolithography, is by reducing the wavelength, and the smallest focal spot will be achieved with a large-diameter beam entering a lens with a short focal length.
- [Twice the Raleigh range or $2 z_R$ is called the "depth of focus" because this is the total distance over which the beam remains relatively parallel, or "in focus" (see Figure).—Graduate only]
- Or also, the depth of focus or depth of field (DOF) is the distance between the values where the beam is $\sqrt{2}$ times larger than it is at the beam waist. This can be derived as :

$$\text{DOF} = 1.27 / \text{NA}^2$$

- Material processing with a very short depth of focus requires a very flat surface. If the surface has a corrugated topology, a servo-loop connected with an interferometric auto ranging device must be used.

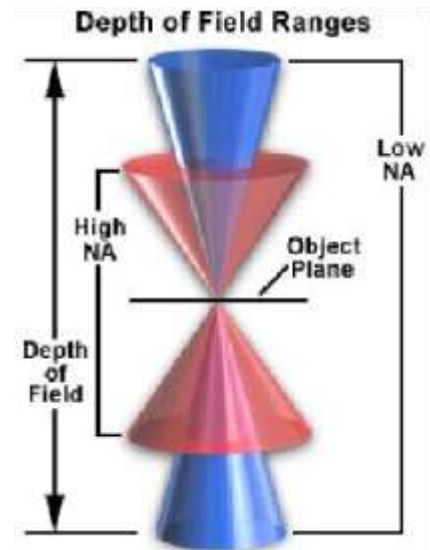

Laser Beam Machining

- Laser ablation is the process of removal of matter from a solid by means of an energy-induced transient disequilibrium in the lattice. The characteristics of the released atoms, molecules, clusters and fragments (the dry aerosol) depend on the efficiency of the energy coupling to the sample structure, i.e., the material-specific absorbance of a certain wavelength, the velocity of energy delivery (laser pulse width) and the laser characteristics (beam energy profile, energy density or fluency and the wavelength).

Laser Parameter	Influence on Material Processing
Power (average)	Temperature (steady state) Process throughput
Wavelength (μm)	Optical absorption, reflection, transmission, resolution, and photochemical effects
Spectral line width (nm)	Temporal coherence Chromatic aberration
Beam size (mm)	Focal spot size Depth of focus Intensity
Lasing modes	Intensity distribution Spatial uniformity Speckle Spatial coherence Modulation transfer function
Peak power (W)	Peak temperature Damage/induced stress Nonlinear effects
Pulse width (sec)	Interaction time Transient processes
Stability (%)	Process latitude
Efficiency (%)	Cost
Reliability	Cost

Laser Beam Machining

- More specifically for micromachining purposes, the wavelength, spot size [i.e., the minimum diameter of the focused laser beam, d_o], average laser beam intensity, depth of focus, laser pulse length and shot-to-shot repeatability (stability and reliability in the Table) are the six most important parameters to control.
- Additional parameters, not listed in the Table, concerns laser machining in a jet of water and laser assisted chemical etching (LACE)-see below.

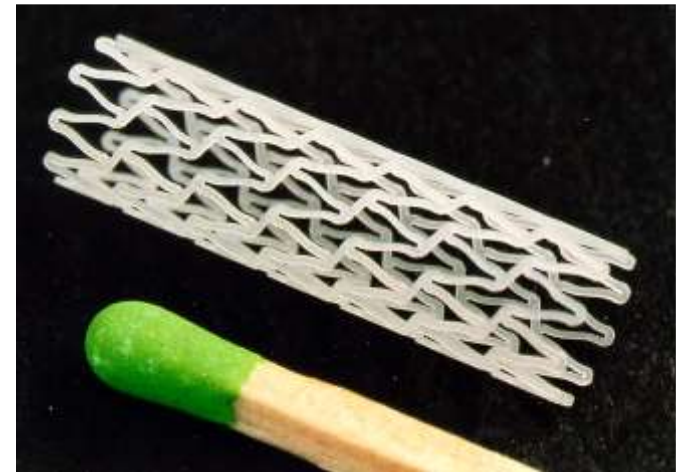

Laser Beam Machining: Heat Affected Zone - HAZ

- The most fundamental feature of laser/material interaction in the long pulse regime (e.g., pulse duration 8 ns, energy 0.5 mJ) is that the heat deposited by the laser in the material diffuses away during the pulse duration; that is, the laser pulse duration is longer than the heat diffusion time. This may be desirable for laser welding, but for most micromachining jobs, heat diffusion into the surrounding material is undesirable and detrimental to the quality of the machining (<http://www.clark-mxr.com>).
- Here are reasons why one should avoid heat diffusion for precise micromachining:
 - Heat diffusion reduces the efficiency of the micromachining process as it takes energy away from the work spot—energy that would otherwise go into removing work piece material. The higher the heat conductivity of the material the more the machining efficiency is reduced.



Laser Beam Machining: Heat Affected Zone - HAZ

- Heat-diffusion affects a large zone around the machining spot, a zone referred to as the heat-affected zone or HAZ. The heating (and subsequent cooling) waves propagating through the HAZ cause mechanical stress and may create micro cracks (or in some cases, macro cracks) in the surrounding material. These defects are "frozen" in the structure when the material cools, and in subsequent routine use these cracks may propagate deep into the bulk of the material and cause premature device failure. A closely associated phenomenon is the formation of a recast layer of material around the machined feature. This resolidified material often has a physical and/or chemical structure that is very different from the unmelted material. This recast layer may be mechanically weaker and must often be removed.
- Heat-diffusion is sometimes associated with the formation of surface shock waves. These shock waves can damage nearby device structures or delaminate multilayer materials. While the amplitude of the shock waves varies with the material being processed, it is generally true that the more energy deposited in the micromachining process the stronger the associated shock waves.

Long Pulse Laser Beam Machining

- The various undesirable effects associated with long laser pulse etching are illustrated here.
- The pulse duration in this example is 8 ns and the energy 0.5 mJ Example of a 25 μm (1 mil) channel machined in 1 mm (40 mils) thick INVAR with a nanosecond laser. INVAR is extremely stable. This sample was machined using a “long” pulse laser. A recast layer can be clearly seen near the edges of the channel. Large debris are also seen in the vicinity of the cut.

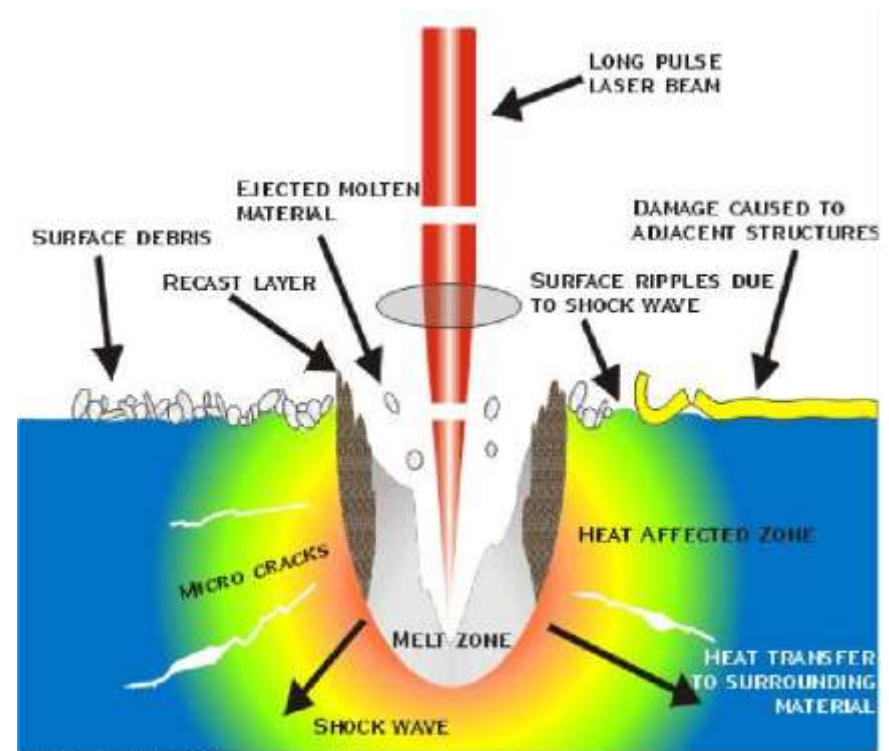
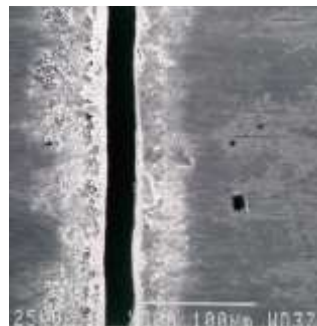

©1999 Clark-MXR, Inc.

(<http://www.clark-mxr.com>).

Short Pulse Laser Beam Machining

- Ultra-short laser pulses have opened up many new possibilities in laser-matter interaction and materials processing. The extremely short pulse width makes it easy to achieve very high peak laser intensity with low pulse energies. The laser intensity can reach $10^{14} \sim 10^{15} \text{W/cm}^2$ with a pulse $< 1 \text{mJ}$ when a sub-pico-second pulse is focused to a spot size of a few tens of micrometers.

Short Pulse Laser Beam Machining

- Using short pulses laser intensity easily reaches the hundreds of terawatts per square centimeter at the work spot itself. No material can withstand the ablation forces at work at these power densities. This means that, with ultrafast laser pulses, very hard materials, such as diamond, as well as materials with extremely high melting points, such as molybdenum and rhenium, can be machined. The most fundamental feature of laser-matter interaction in the very fast pulse regime is that the heat deposited by the laser into the material does not have time to move away from the work spot during the time of the laser pulse. The duration of the laser pulse is shorter than the heat diffusion time. This regime has numerous advantages as listed below (<http://www.clark-mxr.com/industrial/handbook/introduction.htm>):

Short Pulse Laser Beam Machining

- Because the energy does not have the time to diffuse away, the efficiency of the machining process is high. Laser energy piles up at the level of the working spot, whose temperature rises instantly past the melting point of the material and keeps on climbing into what is called the plasma regime.
- After the ultra-fast laser pulse creates the plasma at the surface of the work-piece, the pressures created by the forces within it cause the material to expand outward from the surface in a highly energetic plume or gas. The internal forces that previously held the material together are vastly insufficient to contain this expansion of highly ionized atoms and electrons from the surface. Consequently, there are no droplets that condense onto the surrounding material. Additionally, since there is no melt phase, there is no splattering of material onto the surrounding surface.

Short Pulse Laser Beam Machining

- Heating of the surrounding area is significantly reduced and, consequently, all the negatives associated with a HAZ are no longer present. No melt zone, no micro cracks, no shock wave that can delaminate multilayer materials, no stress that can damage adjacent structures, and no recast layer.

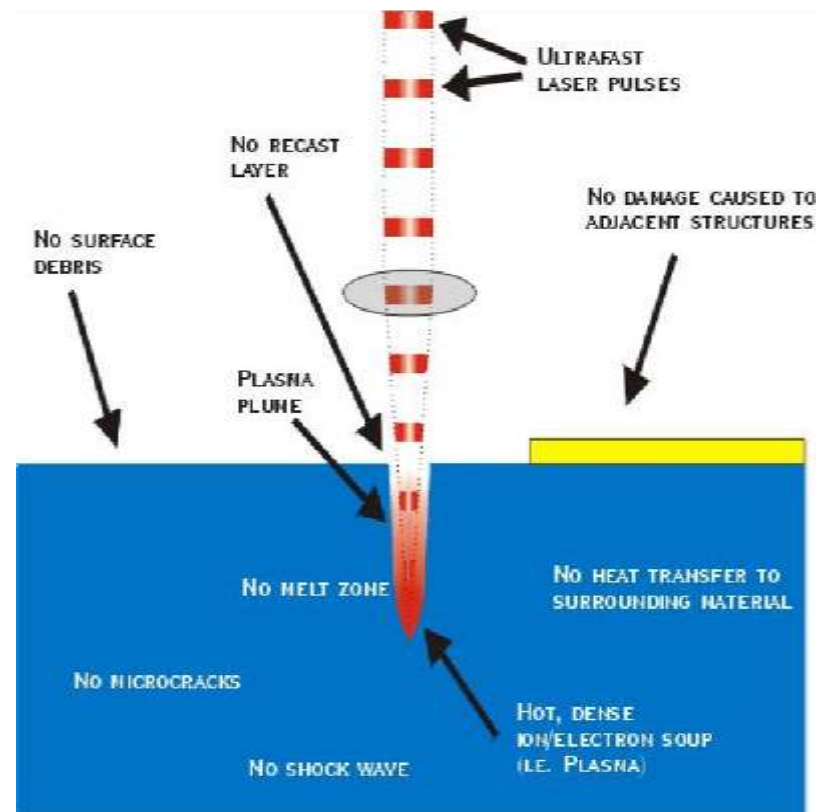

©1999 Clark-MXR, Inc.

Laser Beam Machining

- Advantages:

- Excellent control of the laser beam with a stable motion system achieves an extreme edge quality. Laser-cut parts have a condition of nearly zero edge deformation, or roll-off
- It is also faster than conventional tool-making techniques.
- Laser cutting has higher accuracy rates over other methods using heat generation, as well as water jet cutting.
- There is quicker turnaround for parts regardless of the complexity, because changes of the design of parts can be easily accommodated. Laser cutting also reduces wastage.

- Disadvantages:

- The material being cut gets very hot, so in narrow areas, thermal expansion may be a problem.
- Distortion can be caused by oxygen, which is sometimes used as an assist gas, because it puts stress into the cut edge of some materials; this is typically a problem in dense patterns of holes.
- Lasers also require high energy, making them costly to run.
- Lasers are not very effective on metals such as aluminum and copper alloys due to their ability to reflect light as well as absorb and conduct heat. Neither are lasers appropriate to use on crystal, glass and other transparent materials.

Water Jet Guided Laser Machining

- In water jet guided laser machining, a thin jet of high-pressure water (the diameter of the jet is between 40 and 100 μ m and the water pressure is between 20 and 500 bars) is forced through a nozzle (made of diamond or sapphire). The laser beam is focused through a water chamber (the water is de-ionized and filtered) into a nozzle as shown in the Figure.
- Briefly discuss LACE i.e., laser assisted chemical etching

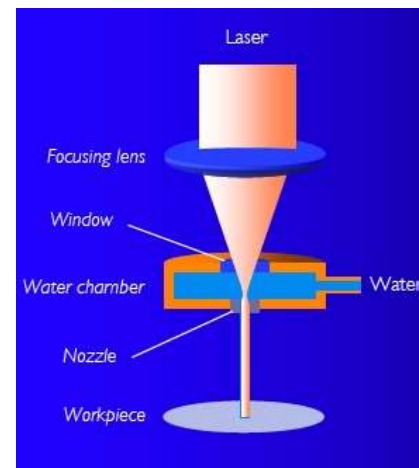
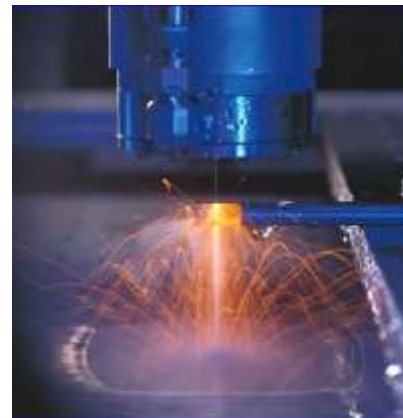

Electron Beam Machining

- Electron-beam removal of materials is another fast-growing thermal technique. Instead of electrical sparks, this method uses a stream of focused, high-velocity electrons from an electron gun to melt and vaporize the work-piece material.
- In EBM, electrons are accelerated to a velocity of 200,000 km/s or nearly three-fourths that of light.

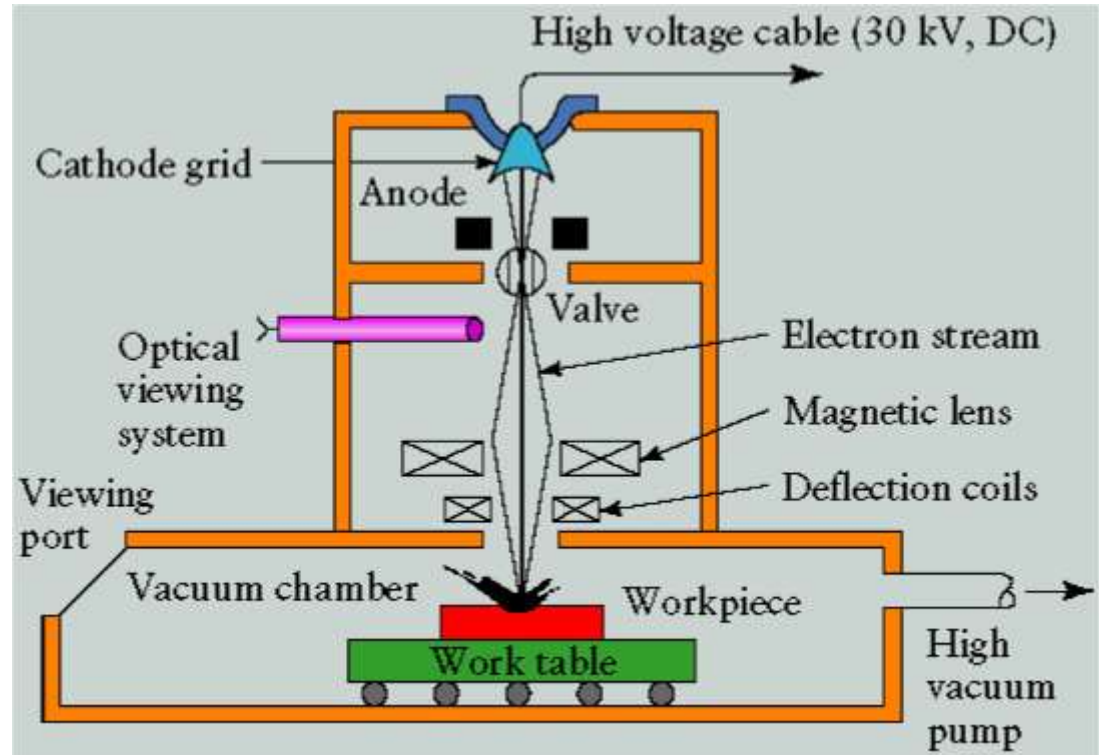

Plasma Beam Machining

- Plasma arc cutting (also plasma arc machining, PAM) is mainly used for cutting thick sections of electrically conductive materials . A high-temperature plasma stream (up to 60,000° F) with the work-piece, causing rapid melting. A typical plasma torch is constructed in such a way that the plasma is confined in a narrow column about 1 mm in diameter.



Plasma Beam Machining

- The basic plasma cutting process involves creating an electrical channel of ionized gas i.e. plasma from the plasma cutter itself, through the work piece to be cut, thus forming a completed electric circuit back to the plasma cutter via a grounding clamp.
- Relatively large cutting speeds can be obtained: for example, 380 mm/min for a stainless steel plate 75 mm thick at an arc current of 800 A.
- Tolerances of ± 0.8 mm can be achieved in materials of thicknesses less than 25 mm, and tolerances of ± 3 mm are obtained for greater thicknesses.
- The HAZ for plasma arc cutting varies between 0.7 and 5 mm in thickness and the method is used primarily for ferrous and nonferrous metals.

What is a laser?

- The word LASER is an acronym which stands for Light Amplification by Stimulated Emission of Radiation. It actually represents the principle itself but is nowadays also used to describe the source of the laser beam.
- The main components of a laser are the laser active, light amplifying medium and an optical resonator which usually consists of two mirrors.

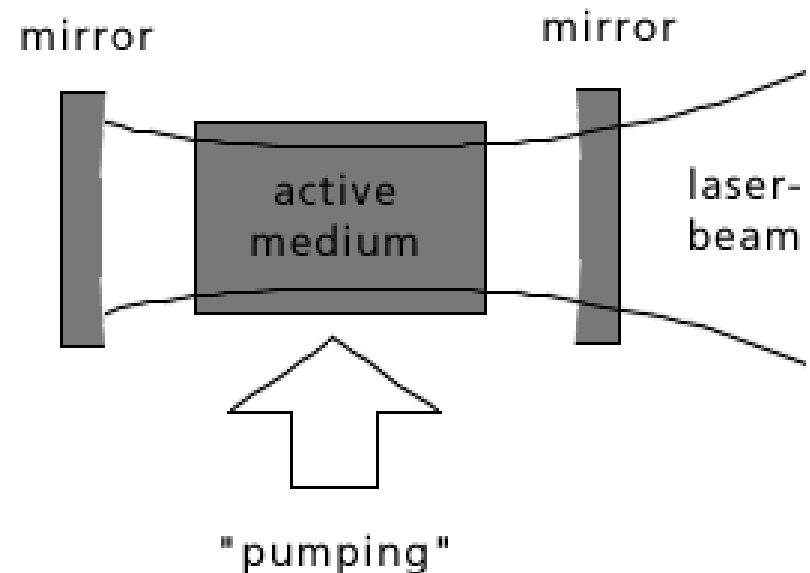

What is a laser?

- **Laser Active Medium:** Laser light is generated in the active medium of the laser. Energy is pumped into the active medium in an appropriate form and is partially transformed into radiation energy. The energy pumped into the active medium is usually highly entropic, i.e. very disorganised, while the resulting laser radiation is highly ordered and thus has lower entropy. Highly entropic energy is therefore converted into less entropic energy within the laser. Active laser media are available in all aggregate states: solid, liquid and gas.

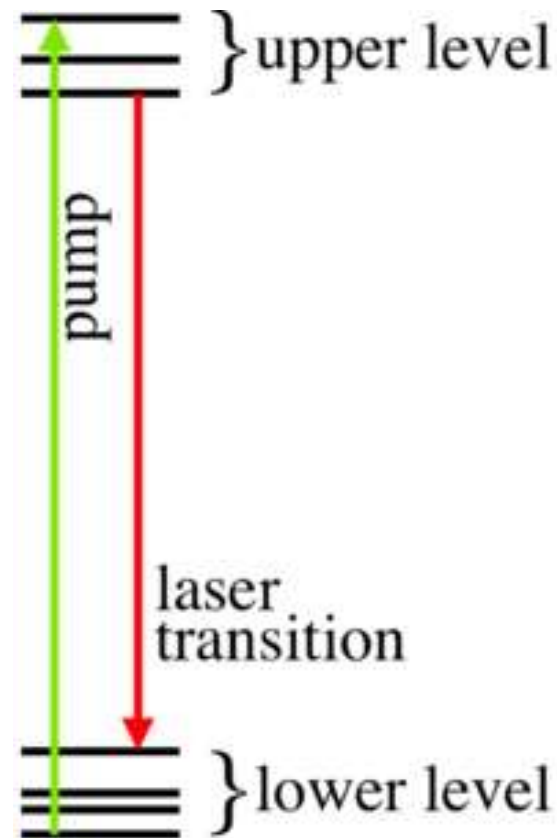

What is a laser?

- **Inversion:** The laser transition of an active medium occurs between two defined levels or level groups - the upper (E_2) and the lower (E_1). Important in terms of laser operation is that an inverted condition is achieved between the two energy levels: the higher energy level must be more densely populated than the lower.
- Inversion is never achieved in systems in thermodynamic equilibrium. Thermal equilibrium is thus characterised by the fact that the lower energy level is always more densely populated than the higher. Lasers must therefore operate in opposite conditions to those which prevail in thermal equilibrium.

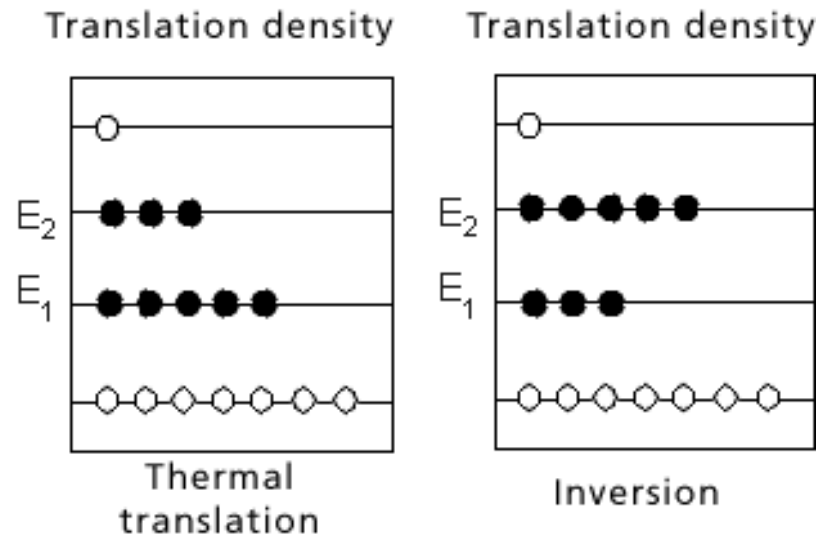

What is a laser?

- Lasing principle: During spontaneous emission of photons, the quanta are emitted in a random direction at a random phase. In contrast, the atoms emitted during stimulated emission are forced into phase by the radiation field. When a number of these in-phase wave trains overlap each other, the resultant radiation field propagates in one direction with a very stable amplitude.

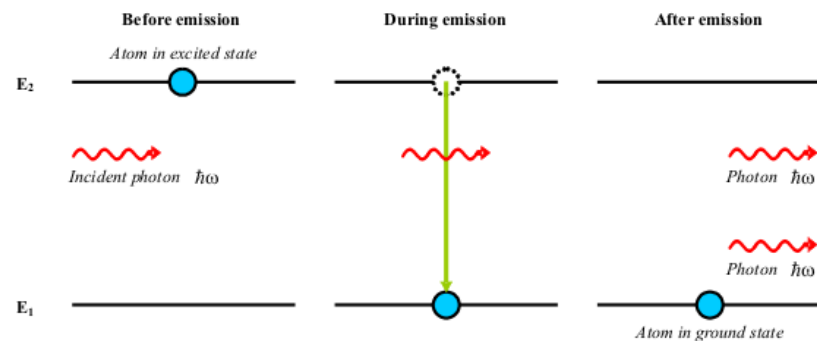
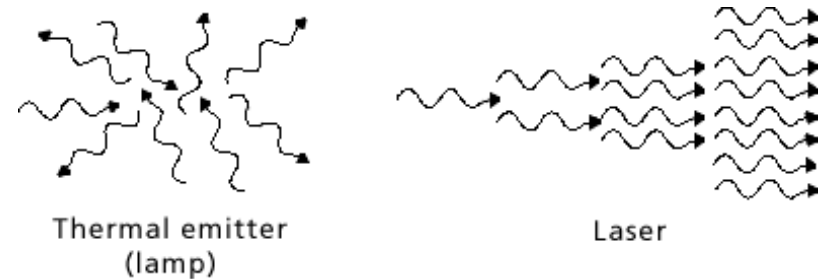

What is a laser?

Two conditions must be met in order to synchronise this stimulated atomic emission: firstly, there must be more atoms present in their higher, excited states than in the lower energy levels, i.e. there must be an inversion. This is necessary otherwise the stimulated emissions of quanta will be directly re-absorbed by the atoms which are present in lower energy states. The inverted condition does not prevail in nature: the lower energy levels are normally more densely populated than the higher levels. Some means of ‘pumping’ the atoms is therefore needed. .

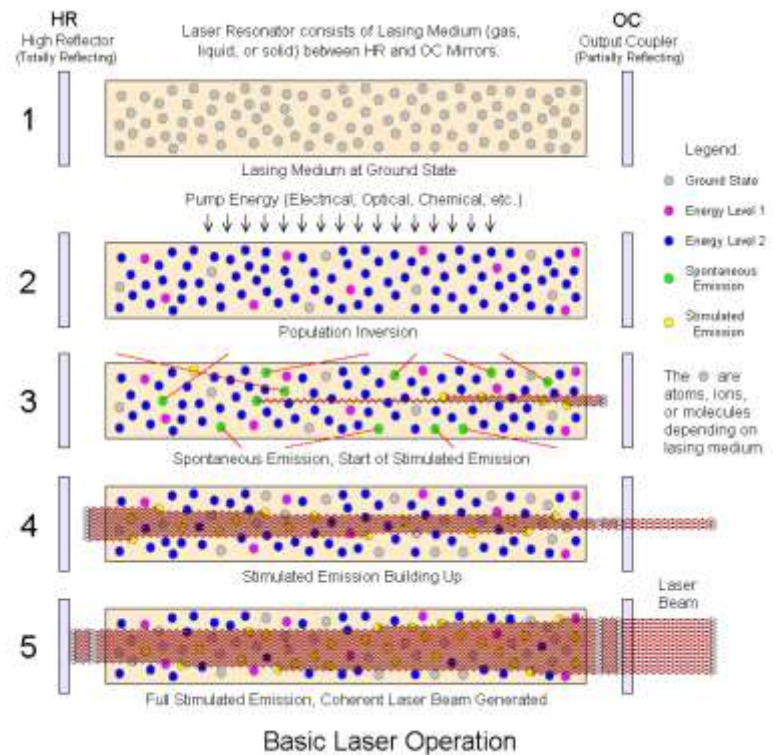

What is a laser?

- Laser pumping is the act of energy transfer from an external source into the gain medium of a laser. The energy is absorbed in the medium, producing excited states in its atoms. When the number of particles in one excited state exceeds the number of particles in the ground state or a less-excited state, population inversion is achieved. In this condition, the mechanism of stimulated emission can take place and the medium can act as a laser or an optical amplifier. The pump power must be higher than the lasing threshold of the laser.
- The pump energy is usually provided in the form of light or electric current, but more exotic sources have been used, such as chemical or nuclear reactions.

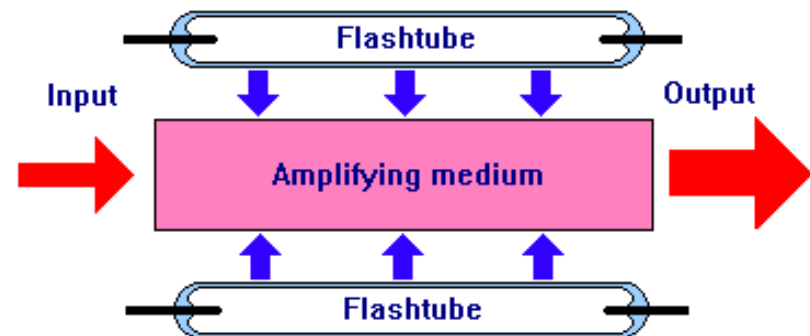

Electron Beam Machining

Group Members:

Sultan Fateh Shair	UW-10-ME-BE-025
Jan e Ali	UW-10-ME-BE-029
Muhammad Adnan Safder	UW-10-ME-BE-031
Kashif Raza	UW-10-ME-BE-033
Ali Naseem	UW-10-ME-BE-035

Electron Beam Machining

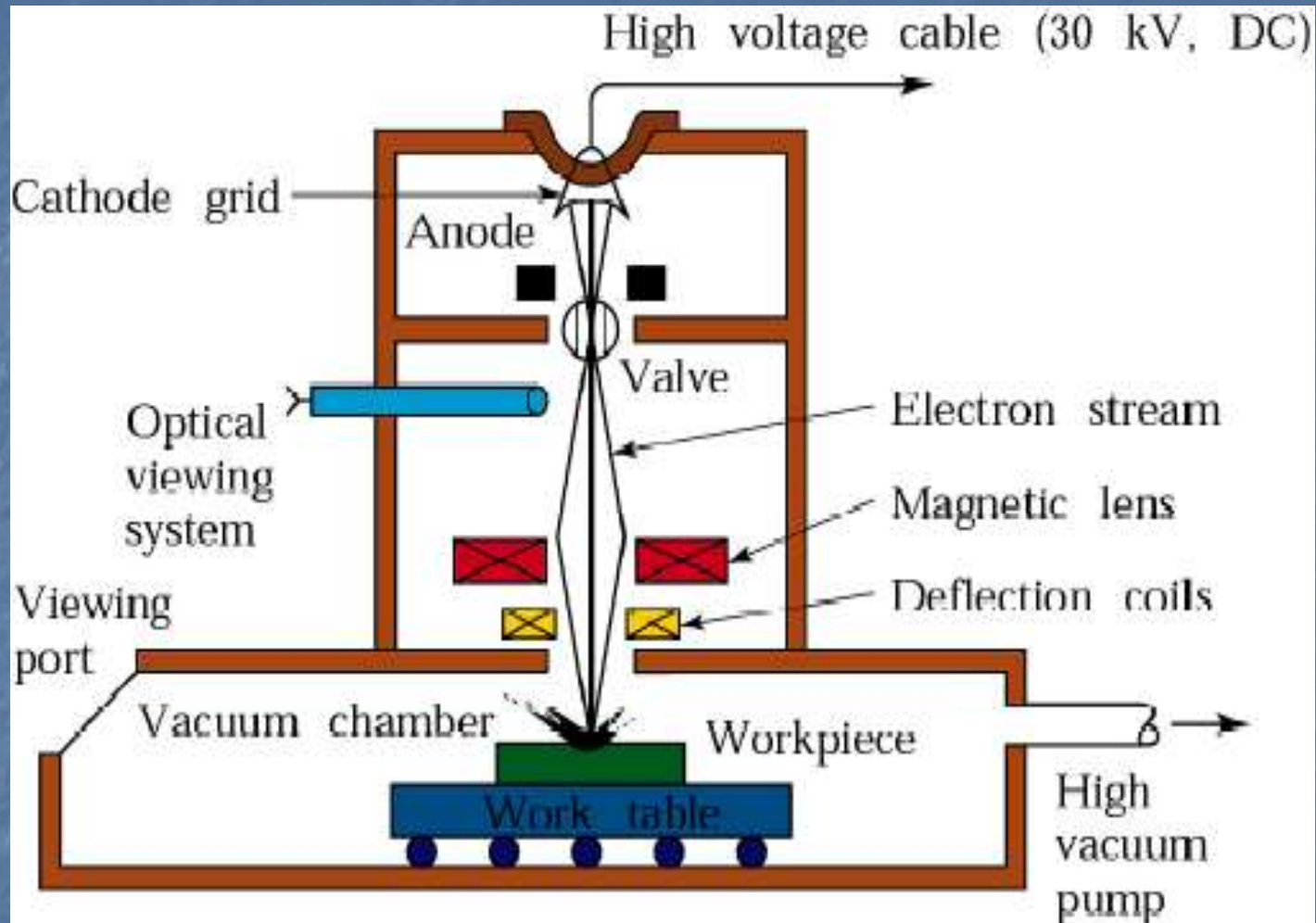

Fig : Schematic illustration of the electron-beam machining process.

Electron Beam Machining

1. Similar to LBM except laser beam is replaced by high velocity electrons.
2. EBM is a metal removal process by a high velocity focused stream of electrons. As the electrons strike the work piece with high velocity , their kinetic energy is transformed into thermal energy which melts and vaporizes the material.
3. The production of free electrons (negatively charged particles) are obtained by electron gun.

Electron Beam Machining

4. Electron beam gun generates free electrons at the cathode, accelerate them to a sufficiently high velocity and to focus them over a small spot size. The gun is operated in pulse mode.
5. The cathode is generally made of tungsten or tantalum. Such cathode filaments are heated, often inductively, to a temperature of around 2500°C.
6. Due to pattern of electrostatic field produced by grid cup, electrons are focused and made to flow in the form of a converging beam through anode. The electrons are accelerated while passing through the anode by applying high voltage at anode

Electron Beam Machining

7. A magnetic deflection coil is used to make electron beam circular and to focus electron beam at a point (localized heating).
8. The process is carried out in a vacuum chamber to prevent electrons from colliding with molecules of the atmospheric air and to prevent tungsten filament from getting oxidizing with air

Mechanism of Material Removal

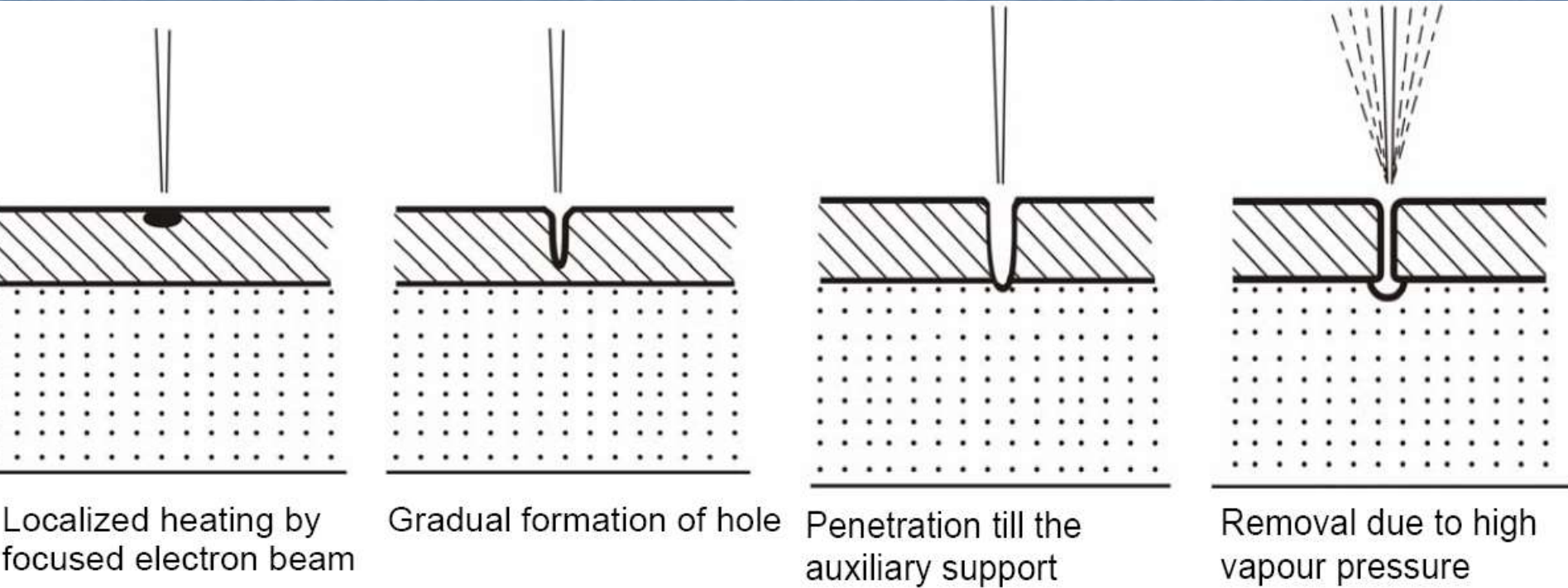

Electron movement

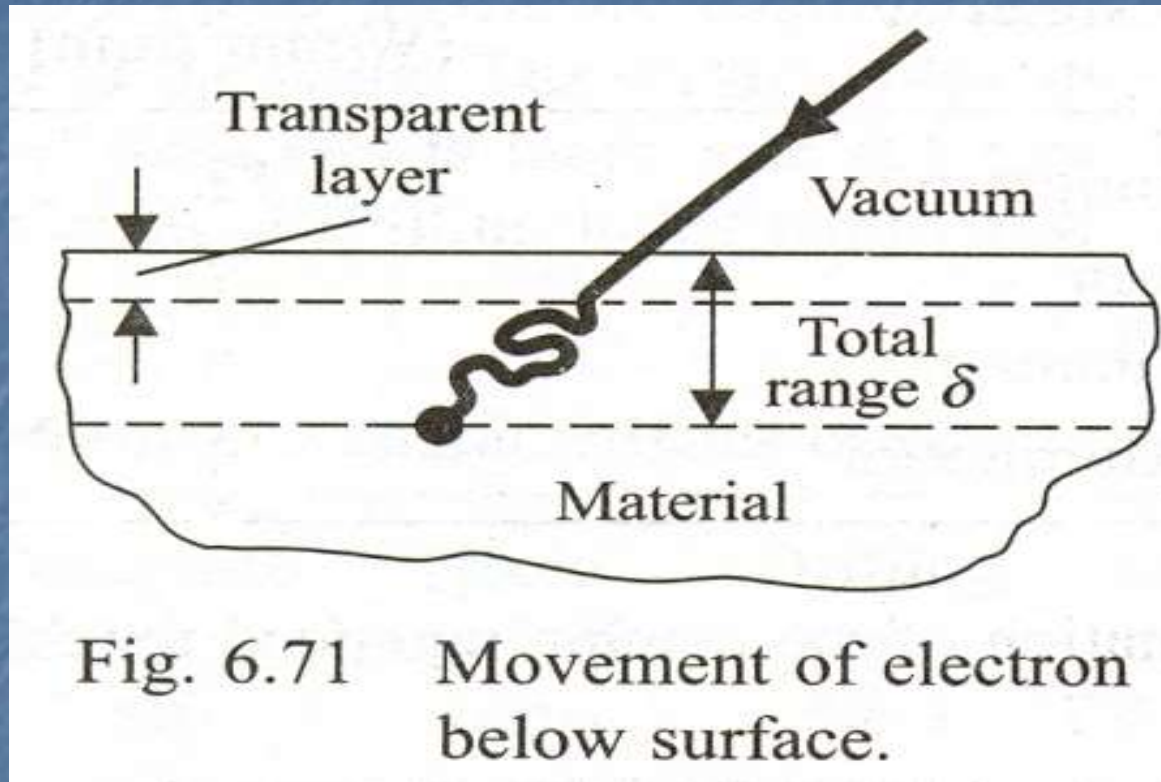

$$\text{Change in KE} = \frac{1}{2}m_e(u^2 - u_0^2) \text{ eV,}$$

$$\text{Total range of electron penetration, } \delta = 2.6 \times 10^{-17} \frac{V^2}{\rho},$$

Figures

1. Level of vacuum within the gun is in the order of 10^{-4} to 10^{-6} Torr. *{1 Torr = 1mm of Hg}*
2. Pulse duration of as low as 50 μ s to as long as 15 ms.
3. Beam current is directly related to the number of electrons emitted by the cathode or available in the beam. Beam current can be as low as 200 μ amp to 1 amp.
4. Increasing the beam current directly increases the energy per pulse. Similarly increase in pulse duration also enhances energy per pulse.
5. High-energy pulses (in excess of 100 J/pulse) can machine larger holes on thicker plates.
6. Typically the heat-affected zone is around 20 to 30 μ m.
7. Material removal rate = 10 mm³/min

Advantages of EBM

1. Very small holes can be machined in every type of material with high accuracy.
2. There is no mechanical contact between tool and work piece, hence no tool wear.
3. Drilling of extremely small diameter holes down to 0.002 in.
4. Drilling holes with high depth/diameter ratios, greater than 100:1.

Disadvantages of EBM

1. Cost of equipment is high
2. Rate of material removal is low
- 3 . It can used for small cuts only
- 4 . Vacuum requirements limits the size of work piece

Application of EBM

1. Drilling of holes in pressure differential devices used in nuclear reactors, air craft engine
2. Machining of wire drawing dies having small cross sectional area.



Thank You!

Electron Beam Machining

Dr. Ufaith Qadiri
Associate Professor

Electron-Beam Machining

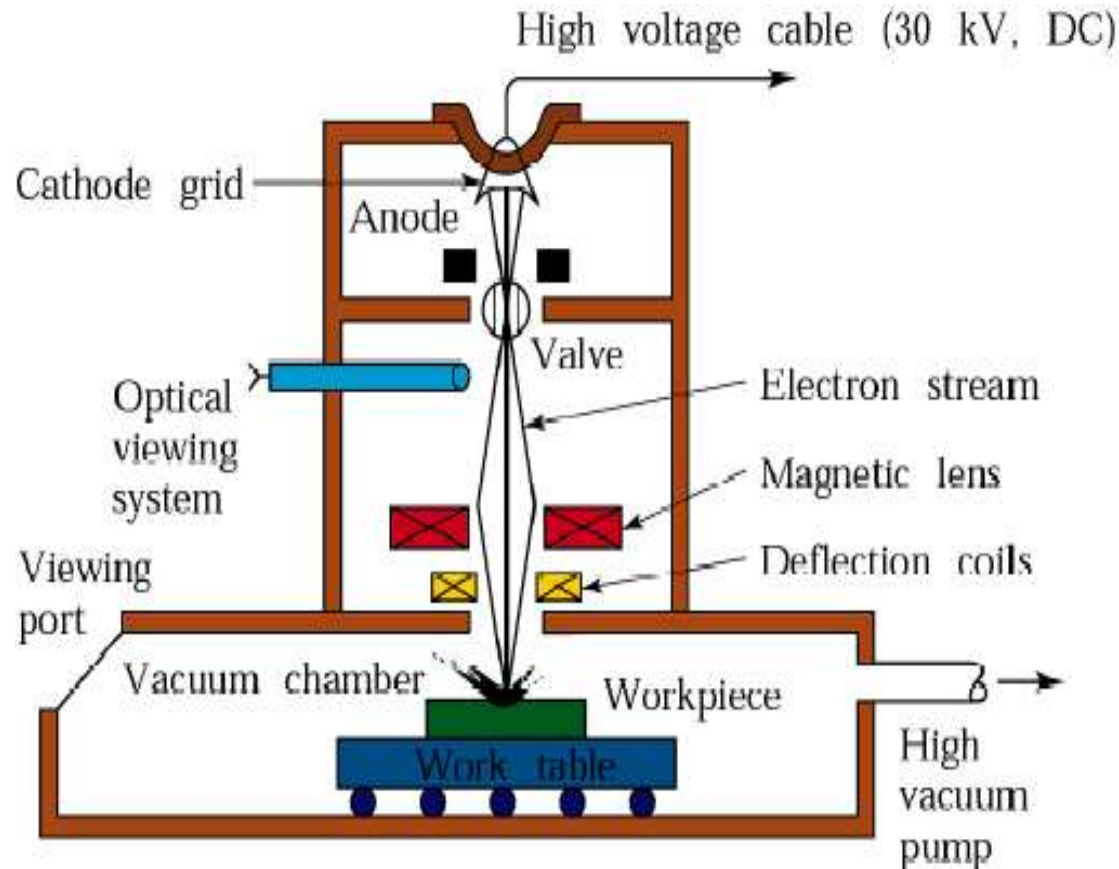
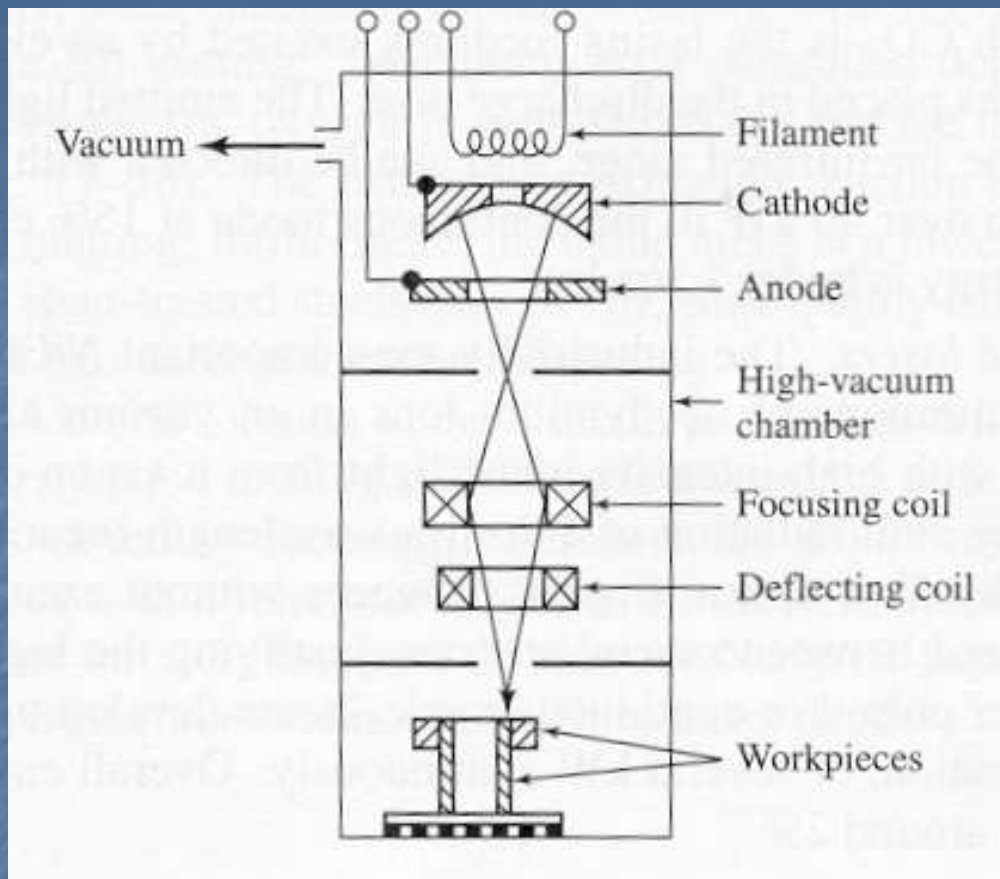

Fig : Schematic illustration of the electron-beam machining process. Unlike LBM, this process requires a vacuum, so workpiece size is limited to the size of the vacuum chamber.



Electron beam machining (line diagram)

Cutting and hole making on thin materials; very small holes and slots (0.1-0.3mm depending on thickness); heat affected zone; require vacuum, expensive equipment; 1-2 mm³/min.

Electron Beam Machining (EBM)

- Part loaded inside a vacuum chamber
- Beam is focused through electromagnetic lens, reducing diameter to as small as 0.025 mm
- Material is vaporized in a very localized area
- Ideal for micro-machining

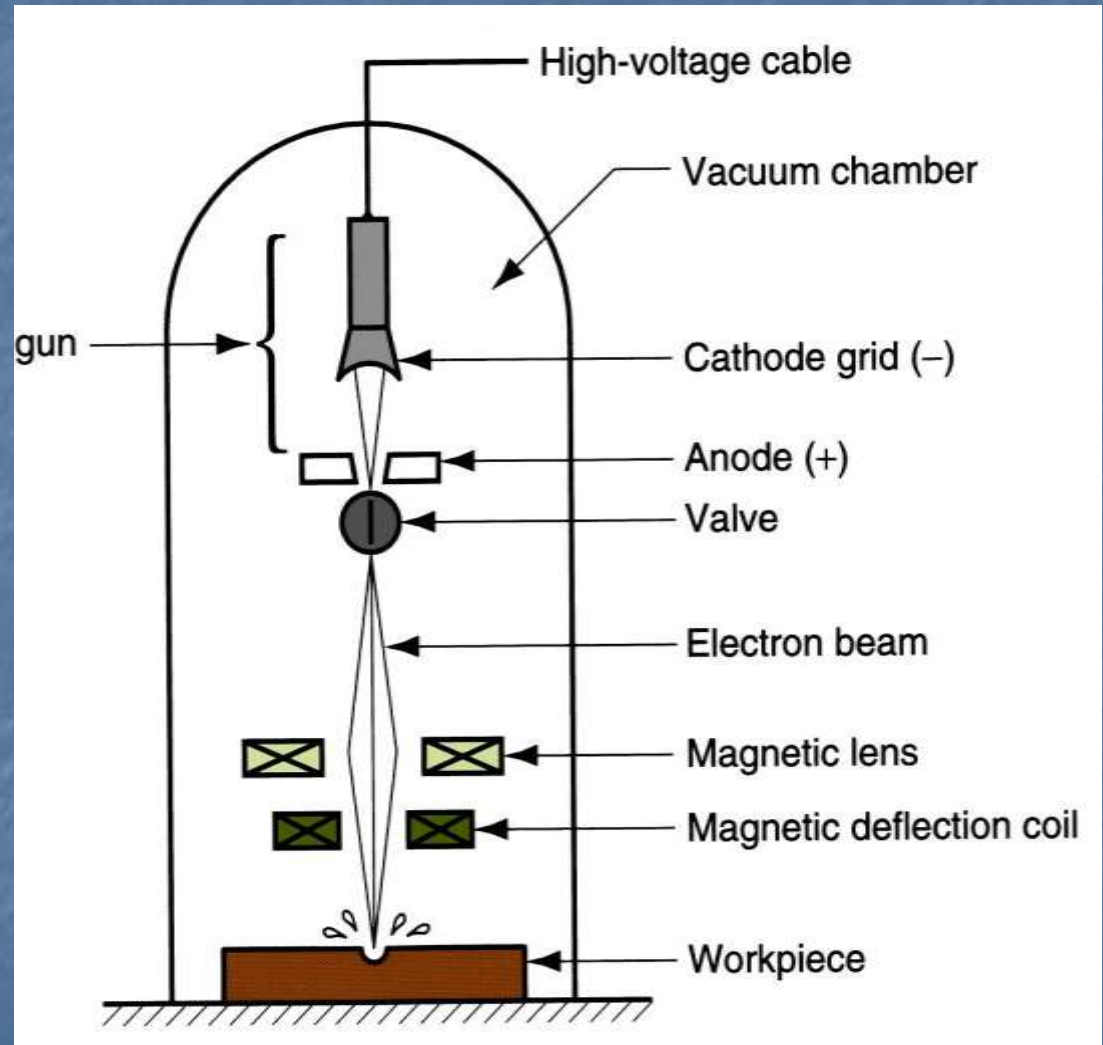

Electron Beam Machining

1. EBM is a metal removal process by a high velocity focused stream of electrons. As the electrons strike the work piece with high velocity , their kinetic energy is transformed into thermal energy which and removes the material.
2. The production of free electrons (negatively charged particles) are obtained by electron gun.
3. Due to pattern of electrostatic field produced by grid cup, electrons are focused and made to flow in the form of a converging beam through anode. The electrons are accelerated while passing through the anode by applying high voltage at anode
4. A magnetic deflection coil is used to make electron beam circular and to focus electron beam at a point (localized heating)
5. The process is carried out in a vacuum chamber to prevent electrons from colliding with molecules of the atmospheric air and to prevent tungsten filament from getting oxidizing with air

Advantages of EBM

1. Very small holes can be machined in every type of material with high accuracy
2. There is no mechanical contact between tool and work piece, hence no tool wear.

Disadvantages of EBM

1. Cost of equipment is high
2. Rate of material removal is low
- 3 . It can used for small cuts only
- 4 . Vacuum requirements limits the size of work piece

Application of EBM

1. Drilling of holes in pressure differential devices used in nuclear reactors, air craft engine
2. Machining of wire drawing dies having small cross sectional area.

Advanced Machining Processes

Manufacturing
Processes

By

Dr.Ufaith Qadiri

Outline

- Chemical Milling
- Photochemical Blanking
- Electrochemical Machining
- Pulsed Electrochemical Machining
- Electrochemical Grinding
- Electrical-Discharge Machining
- Electrical-Discharge Grinding
- Electrical-Discharge Wire Cutting
- Laser-Beam Machining
- Electron Beam Machining
- Plasma Arc Cutting
- Water Jet Machining
- Abrasive Water Jet Machining
- Abrasive Jet Machining

Examples of Parts

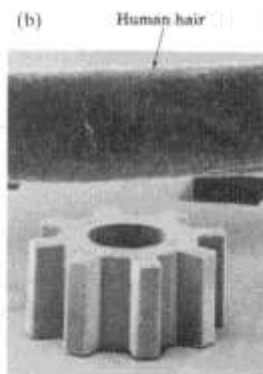

FIGURE 26.1 Examples of parts made by advanced machining processes. These parts are made by advanced machining processes and would be difficult or uneconomical to manufacture by conventional processes. (a) Cutting sheet metal with a laser beam. *Courtesy of RoFin-Sinar, Inc., and Manufacturing Engineering Magazine, Society of Manufacturing Engineers.* (b) Microscopic gear with a diameter on the order of $100\ \mu\text{m}$, made by a special etching process. *Courtesy of Wisconsin Center for Applied Microelectronics, University of Wisconsin-Madison.*

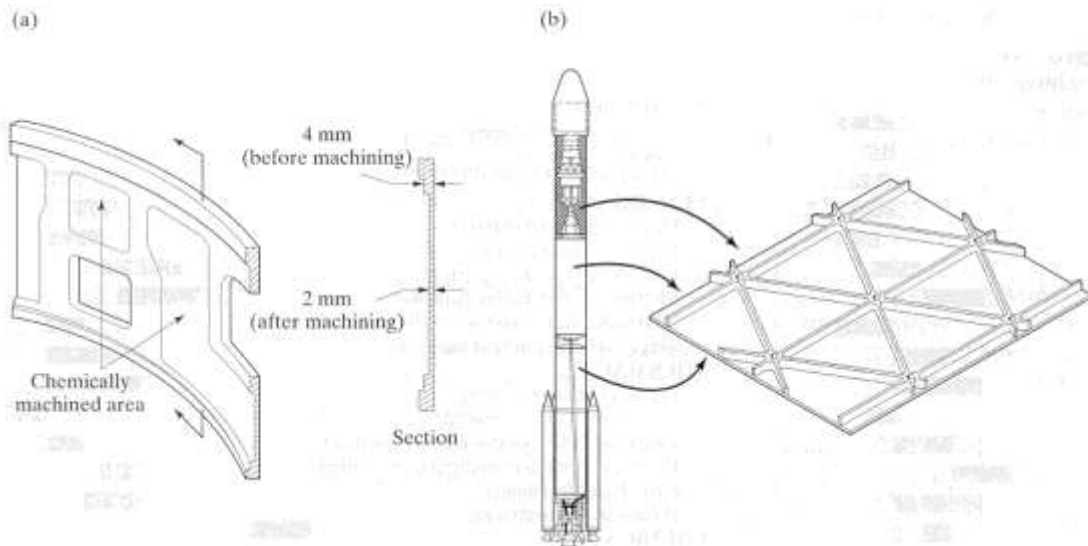

FIGURE 26.2 (a) Missile skin-panel section contoured by chemical milling to improve the stiffness-to-weight ratio of the part. (b) Weight reduction of space launch vehicles by chemical milling aluminum-alloy plates. These panels are chemically milled after the plates have first been formed into shape by processes such as roll forming or stretch forming. The design of the chemically machined rib patterns can be modified readily at minimal cost. *Source: Advanced Materials and Processes, December 1990. ASM International.*

Chemical Milling

Produces shallow cavities on a workpiece, usually to reduce weight

The area affected by the chemical reagent is controlled by masking or by partial immersion

Chemical Milling

FIGURE 26.3 (a) Schematic illustration of the chemical machining process. Note that no forces or machine tools are involved in this process. (b) Stages in producing a profiled cavity by chemical machining; note the undercut.

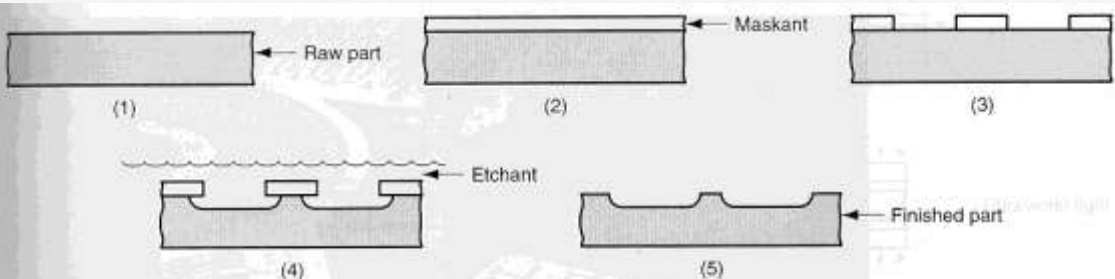
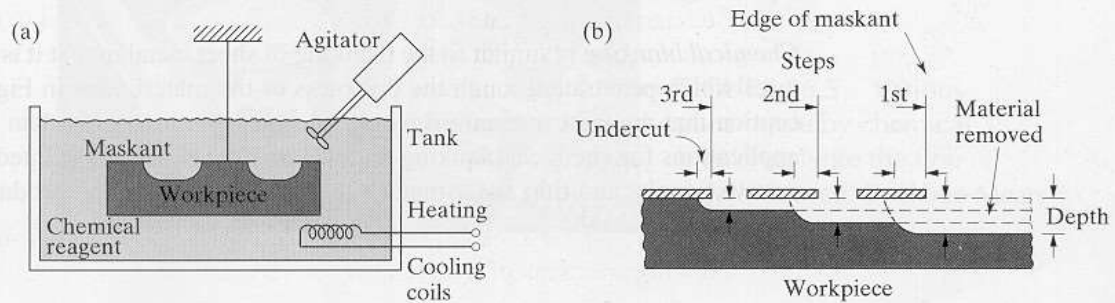

FIGURE 27.19 Sequence of processing steps in chemical milling: (1) clean raw part, (2) apply maskant, (3) scribe, cut, and peel the maskant from areas to be etched, (4) etch, and (5) remove maskant and clean to yield finished part.

Chemical Milling

Procedure:

1. Relieve residual stresses to prevent warping
2. Clean the material surface
3. Apply masking material
4. Remove the masking on regions that require etching
5. Apply the reagents
6. Wash the part
7. Remove remaining masking
8. Additional finishing or chemical milling procedures may be used

Photochemical Blanking

Uses chemicals and photographic processes to remove material, usually from a thin sheet

Can produce complex shapes on metals as thin as .0025 mm without forming burrs

Photochemical Blanking

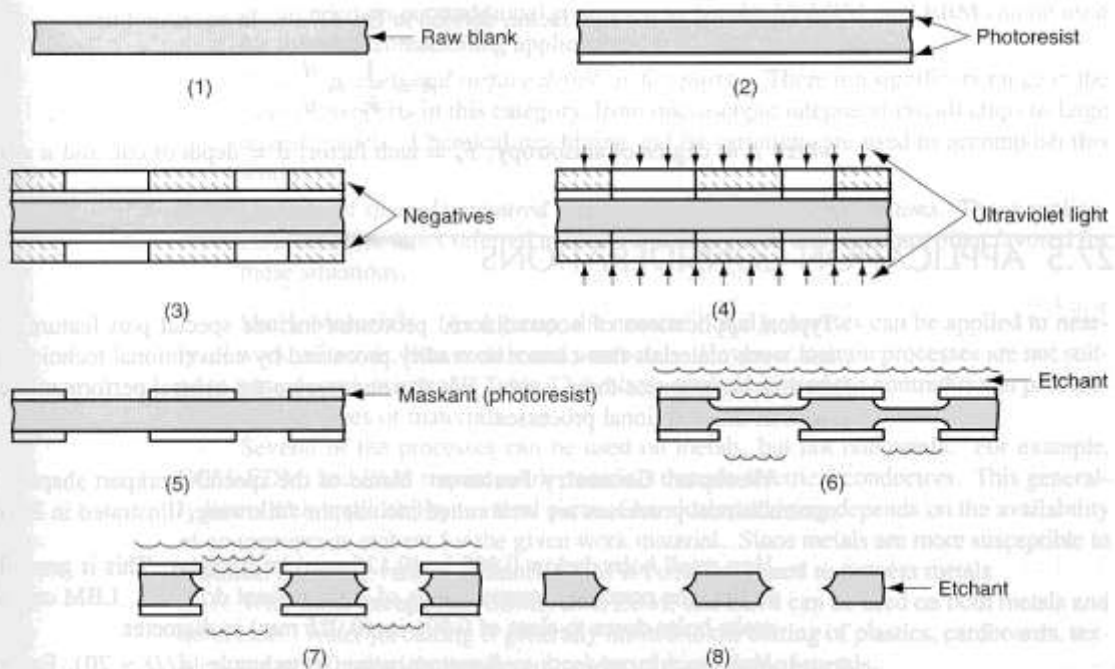

FIGURE 27.22 Sequence of processing steps in photochemical machining: (1) clean raw part, (2) apply resist (maskant) by dipping, spraying, or painting, (3) place negative on resist, (4) expose to ultraviolet light, (5) develop to remove resist from areas to be etched, (6) etch (shown partially etched), (7) etch (completed), and (8) remove resist and clean to yield finished part.

Examples of Parts

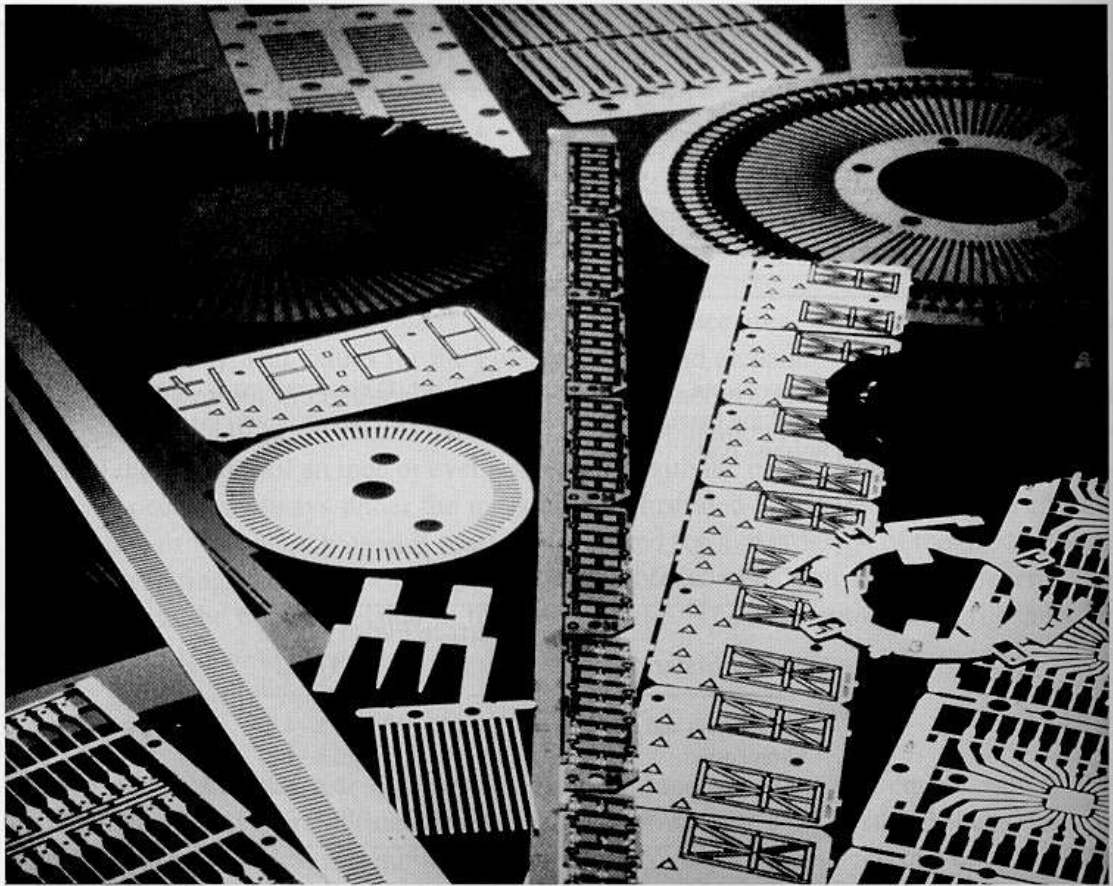

FIGURE 27.21 Parts made by chemical blanking (courtesy Buckbee-Mears St. Paul).

Photochemical Blanking

Procedure:

1. Prepare the design at a magnification of up to 100x; make a photographic negative and reduce it to the size of the part
2. Coat the blank with photosensitive material
3. Place the negative over the part and expose it to ultraviolet light to harden the exposed photosensitive coating
4. Dissolve the unexposed coating
5. Apply the chemical reagent
6. Remove the masking and wash the part

Chemical Machining

Design Considerations:

- Avoid sharp corners, deep narrow cavities, steep tapers, folded seams and porous workpieces
- Undercuts may develop
- Most of the workpiece should be shaped by other processes to speed production
- Variations may occur depending on humidity and temperature
- Computerized designs must be converted to a format compatible with the photochemical artwork equipment

Electrochemical Machining

Uses an electrolyte and electrical current to ionize and remove metal atoms

Can machine complex cavities in high-strength materials

Leaves a burr-free surface

Not affected by the strength, hardness or toughness of the material

Electrochemical Machining

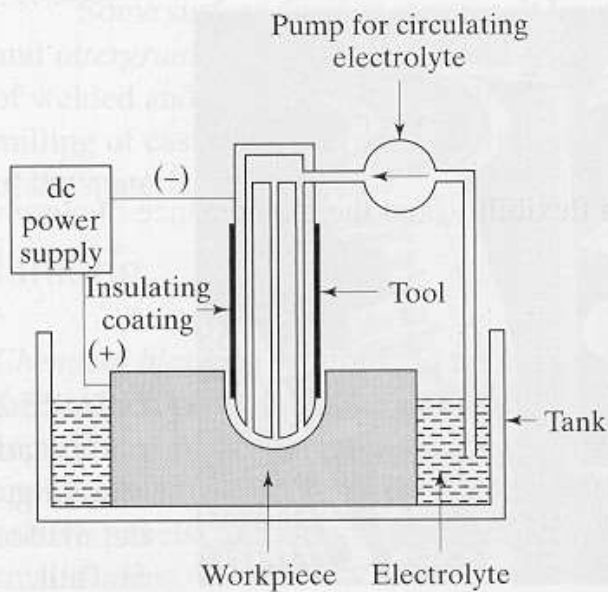

FIGURE 26.6 Schematic illustration of the electrochemical-machining process. This process is the reverse of electroplating, described in Section 33.8.

Electrochemical Machining

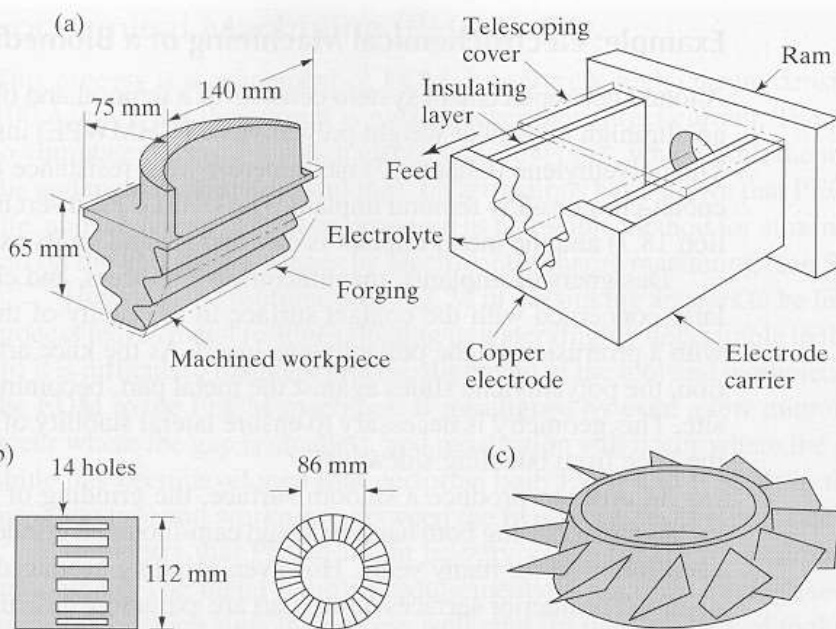

FIGURE 26.7 Typical parts made by electrochemical machining. (a) Turbine blade made of a nickel alloy, 360 HB; note the shape of the electrode on the right. Source: ASM International. (b) Thin slots on a 4340-steel roller-bearing cage. (c) Integral airfoils on a compressor disk.

Electrochemical Machining

Design Considerations:

- The electrolyte erodes away sharp profiles
- It is difficult to control electrolyte flow; irregular cavities may not be formed accurately
- Allow for small taper in holes made this way

Pulsed Electrochemical Machining

A form of electrochemical
machining; the current is
pulsed to eliminate the need
for high electrolyte flow

Improves fatigue life of the part

Electrochemical Grinding

Uses a rotating cathode embedded with abrasive particles for applications comparable to milling, grinding and sawing

Most of the metal removal is done by the electrolyte, resulting in very low tool wear

Adaptable for honing

Electrochemical Grinding

FIGURE 26.9 (a) Schematic illustration of the electrochemical-grinding process. (b) Thin slot produced on a round nickel-alloy tube by this process.

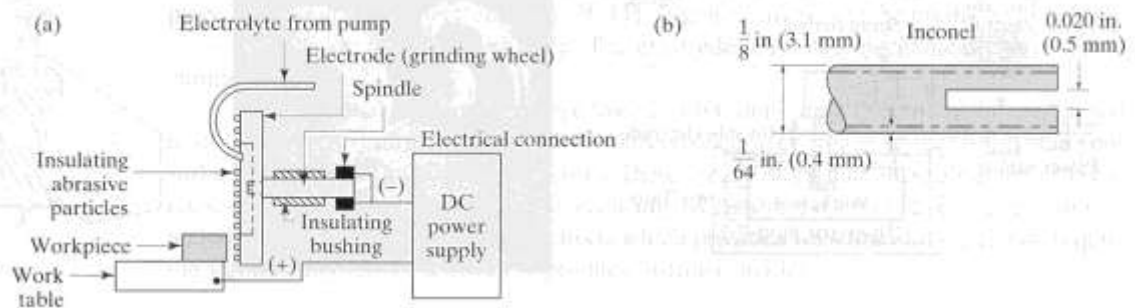

Electrochemical Grinding

Design Considerations:

(in addition to those for
electrochemical machining)

- Avoid sharp inside radii
- Flat surfaces to be ground should be narrower than the width of the grinding wheel

Electrical-Discharge Machining

Uses a shaped electrode and electric sparks to remove metal; discharges sparks at about 50-500 kHz

A dielectric (nonconductive) fluid removes debris and acts as an insulator until the potential difference is high enough

Can be used on any material that conducts electricity

Electrical-Discharge Machining

FIGURE 26.10 (a) Schematic illustration of the electrical-discharge machining process. This is one of the most widely used machining processes, particularly for die-sinking operations. (b) Examples of cavities produced by the electrical-discharge machining process, using shaped electrodes. Two round parts (rear) are the set of dies for extruding the aluminum piece shown in front (see also Fig. 15.9b). *Source:* Courtesy of AGIE USA Ltd. (c) A spiral cavity produced by EDM using a slowly rotating electrode, similar to a screw thread. *Source:* *American Machinist*.

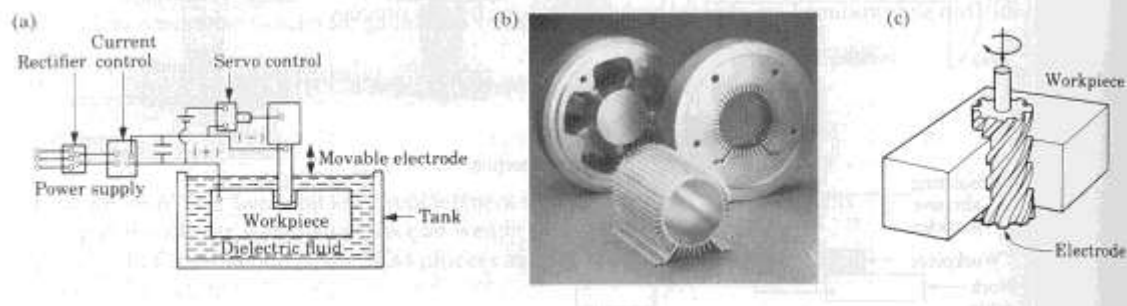

Electrical-Discharge Machining

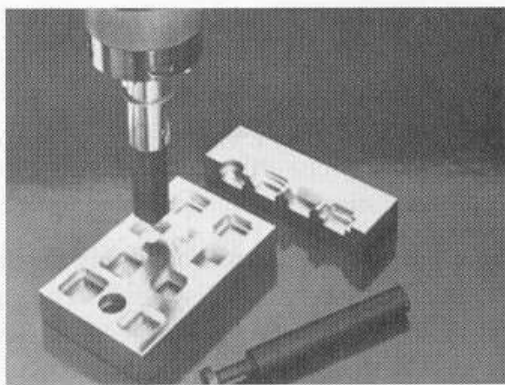

FIGURE 26.11 Stepped cavities produced with a square electrode by the EDM process. The workpiece moves in the two principal horizontal directions (x - y), and its motion is synchronized with the downward movement of the electrode to produce these cavities. Also shown is a round electrode capable of producing round or elliptical cavities. *Source:* Courtesy of AGIE USA Ltd.

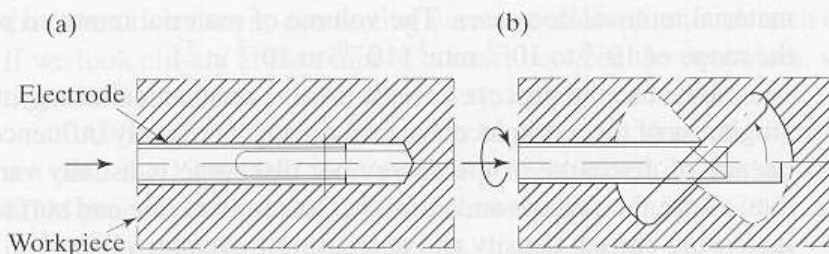

FIGURE 26.12 Schematic illustration of producing an inner cavity by EDM, using a specially designed electrode with a hinged tip, which is slowly opened and rotated to produce the large cavity. *Source:* Luziesca France.

Electrical-Discharge Machining

Design Considerations:

- Design parts so that the electrodes can be made economically
- Avoid deep slots and narrow openings
- Do not require very fine surface finish
- Most of the material removal should be done by other processes to speed production

Electrical-Discharge Grinding

The grinding wheel lacks
abrasives and removes
material by electrical
discharges

Can be combined with
electrochemical grinding

Can be used for sawing, in which
the saw has no teeth

Electrical-Discharge Wire Cutting

The wire moves through the workpiece like a band saw, removing material by electrical discharge

Dielectric fluid is applied to the work area

The wire is generally used only once; it is inexpensive

Electrical-Discharge Wire Cutting

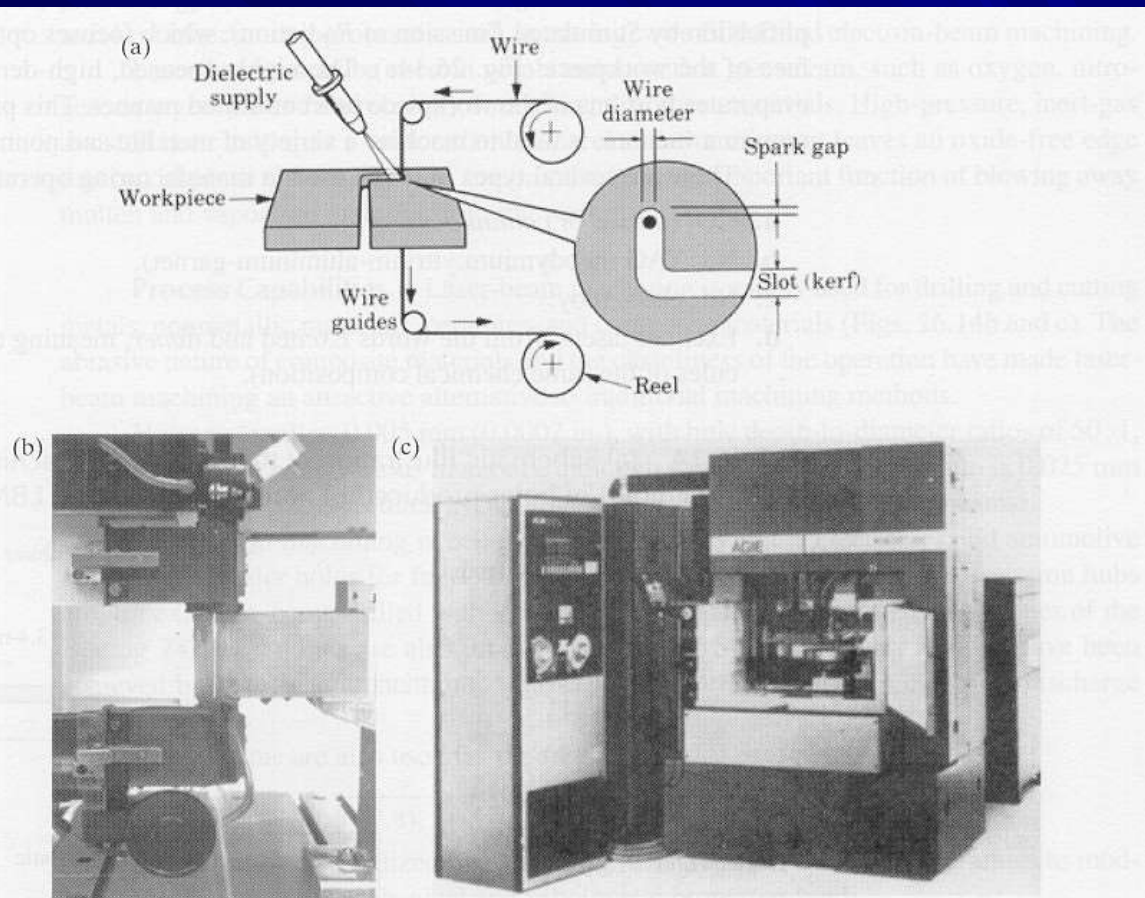

FIGURE 26.13 (a) Schematic illustration of the wire EDM process. As much as 50 hours of machining can be performed with one reel of wire, which is then discarded. (b) Cutting a thick plate with wire EDM. (c) A computer-controlled wire EDM machine. *Source:* Courtesy of AGIE USA Ltd.

Electrical-Discharge Wire Cutting



Example of a wire EDM machine

Courtesy of Edison Industrial Service Center

Electrical-Discharge Wire Cutting



Example of a wire EDM machine

Courtesy of Edison Industrial Service Center

Electrical-Discharge Wire Cutting

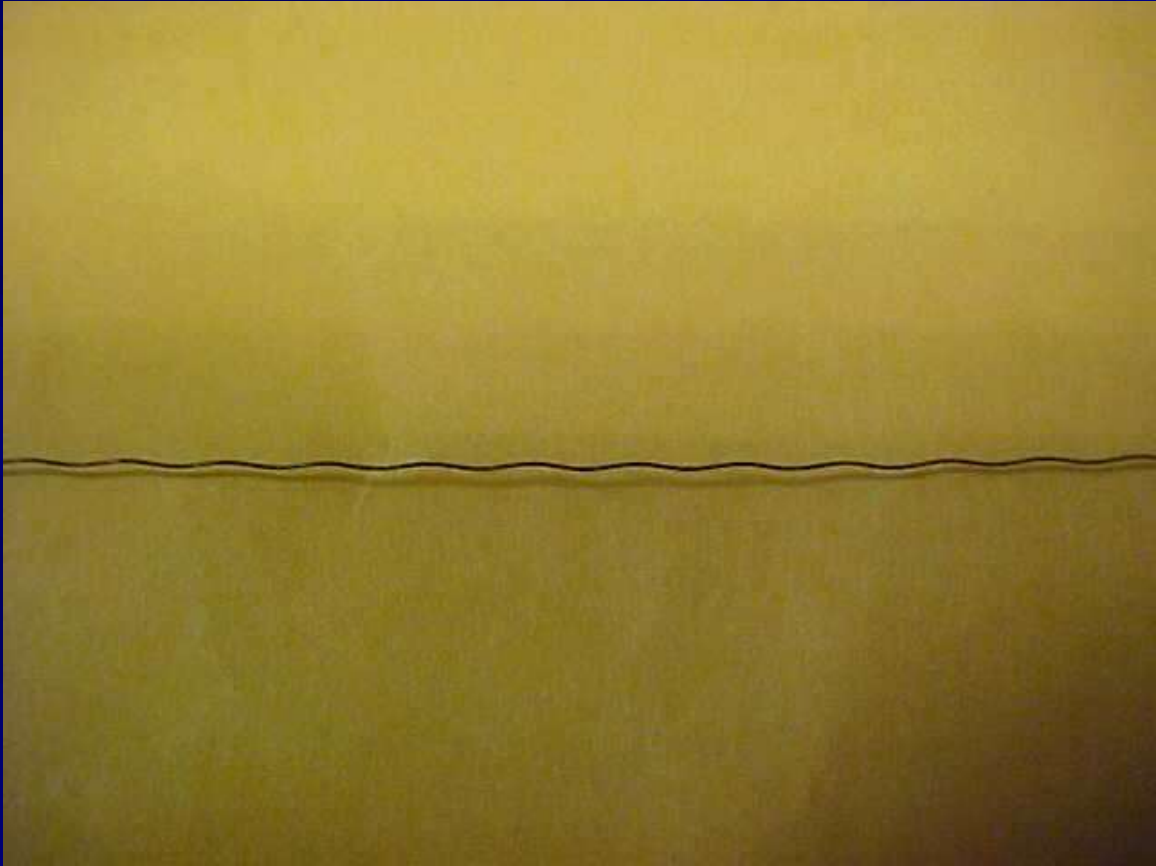

Example of a wire used for an EDM machine

This wire has been used; the wave pattern was
formed during take-up

Courtesy of Edison Industrial Service Center

Electrical-Discharge Wire Cutting

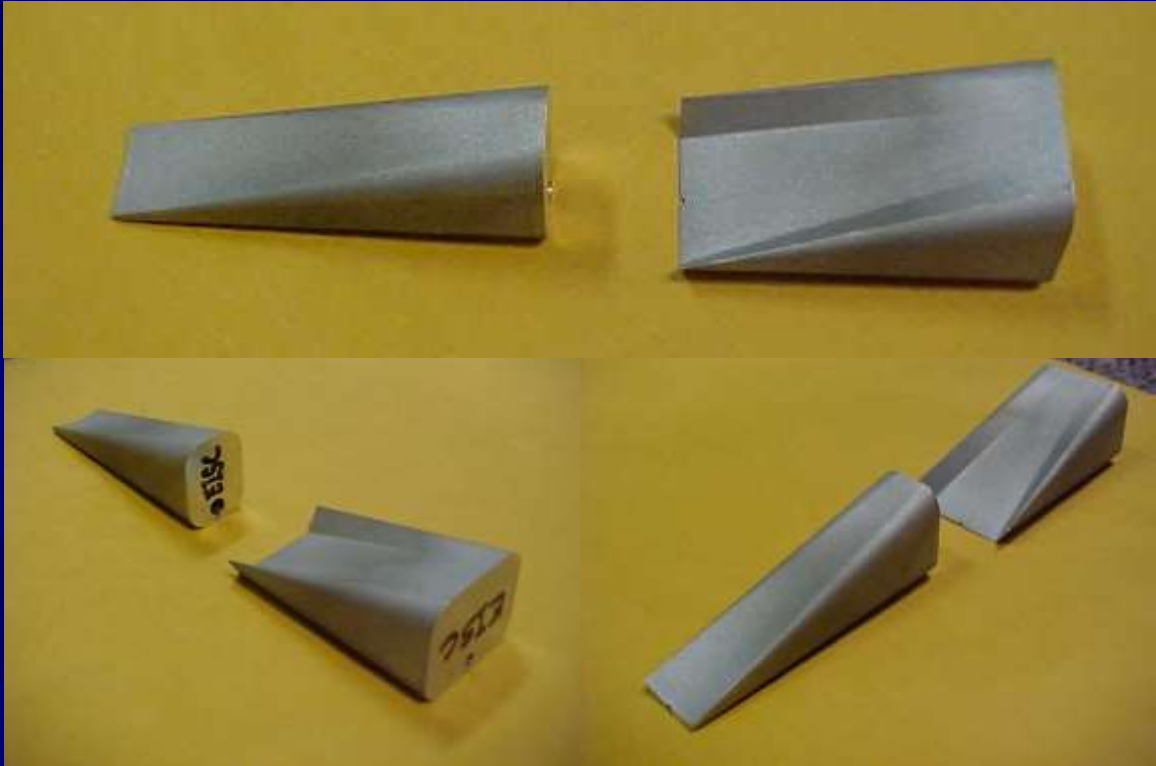

Example of cores removed from a part using wire EDM to create the cavity in a high-pressure nozzle

Holes were drilled in the interiors so that the wire could be strung through

Courtesy of Edison Industrial Service Center

Laser-Beam Machining

Uses a concentrated beam of light to vaporize part of the workpiece

Usually produces a rough surface with a heat-affected zone

Can cut holes as small as .005 mm with depth/diameter ratios of 50:1

Laser-Beam Machining

FIGURE 26.14 (a) Schematic illustration of the laser-beam machining process. (b) and (c) Examples of holes produced in nonmetallic parts by LBM.

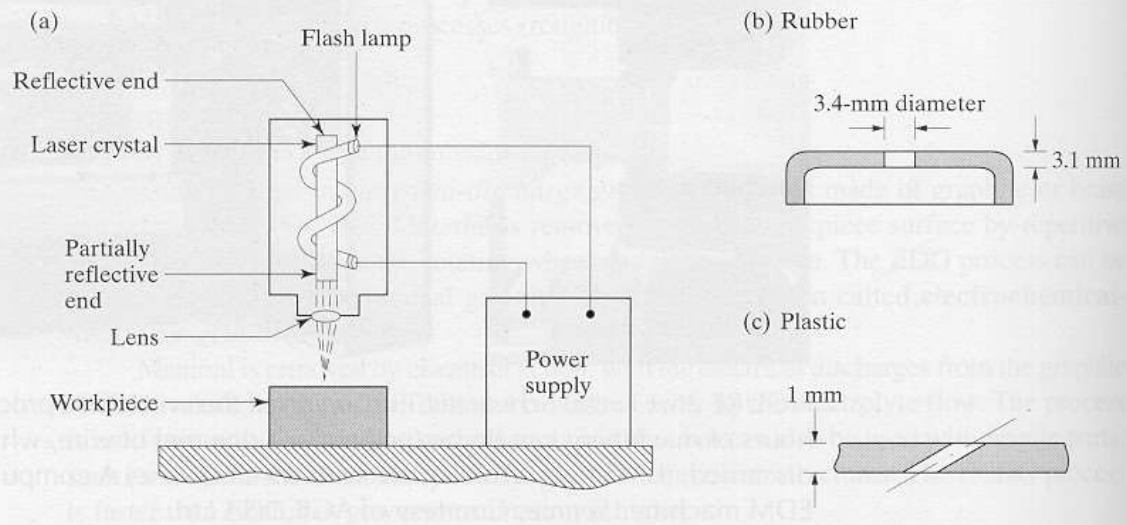

Laser-Beam Machining



Laser-Beam Machining



Example of a part cut by laser-beam machining

Splatter marks appear where the laser first cuts into the material

Laser-Beam Machining

Design Considerations:

- Non-reflective workpiece surfaces are preferable
- Sharp corners are difficult to produce; deep cuts produce tapers
- Consider the effects of high temperature on the workpiece material

Electron Beam Machining

Vaporizes material using
electrons accelerated to 50-
80% the speed of light

Produces finer surface finish and
narrower cut width than other
thermal cutting processes

Requires a vacuum; generates
hazardous X rays

Electron Beam Machining

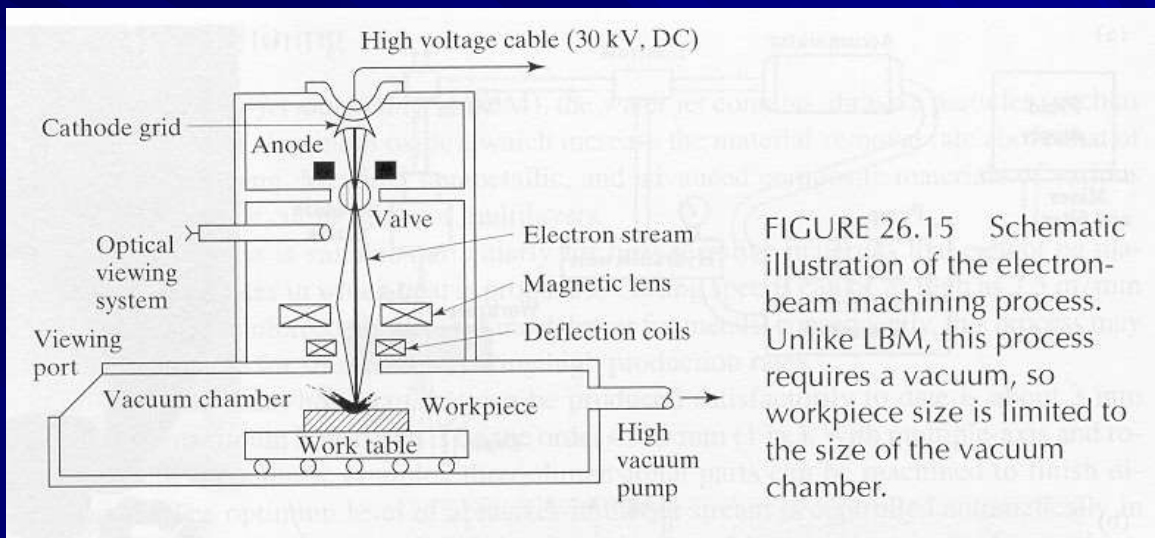

Electron Beam Machining



An electron beam in a very low-pressure
atmosphere of helium

Plasma Arc Cutting

Uses plasma (ionized gas) to rapidly vaporize material

Material removal rates are much higher than those for laser beam machining and electron beam machining; produces good surface finish and thin cut width

Plasma Arc Cutting

FIGURE 27.17 Plasma arc cutting (PAC).

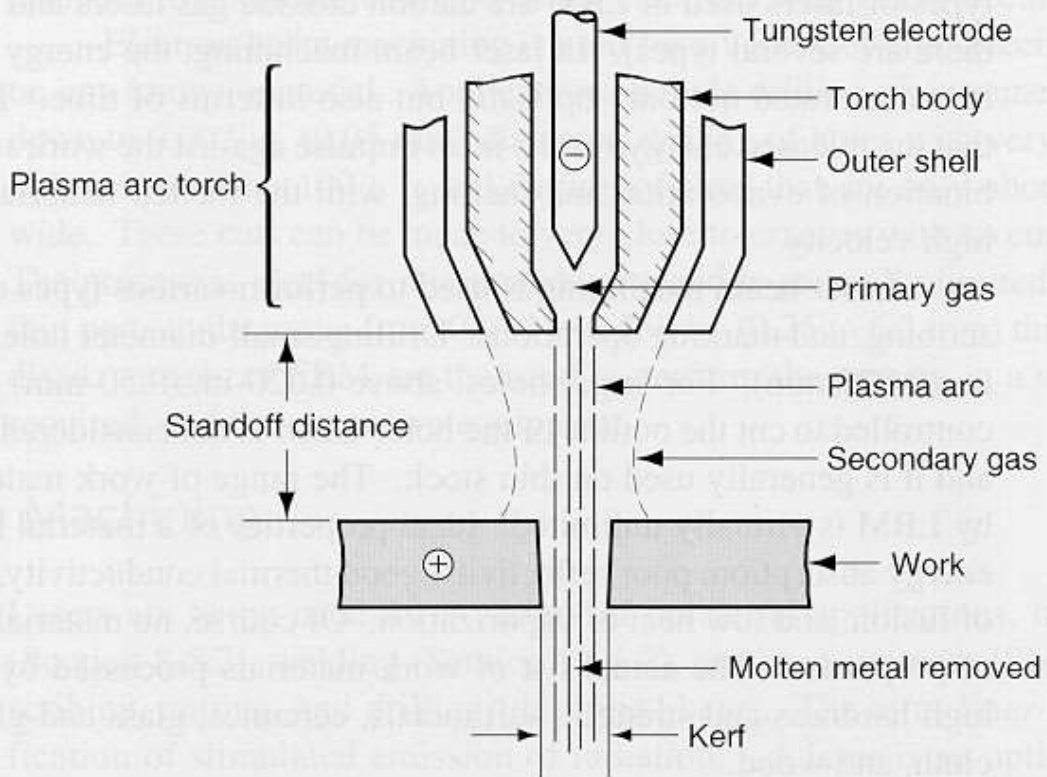

Plasma Arc Cutting

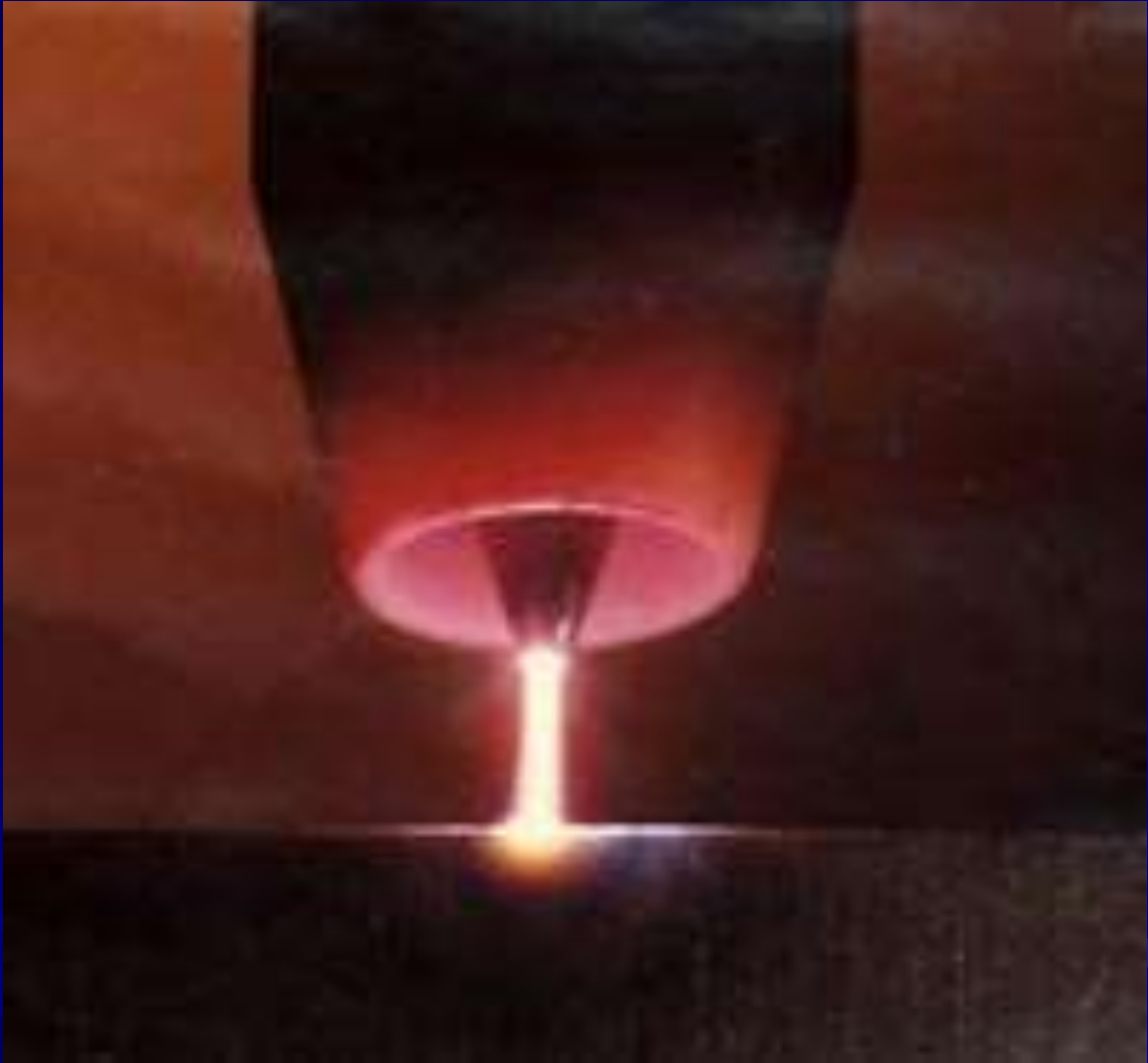

Close-up view of a plasma arc

Plasma Arc Cutting



Electron Beam Machining and Plasma Arc Cutting

Design Considerations:

(in addition to those for laser-beam machining)

- Parts should match the size of the vacuum chamber
- Consider manufacturing the part as a number of smaller components

Water Jet Machining

A pressurized jet of water cuts a groove in the material

Effective for many nonmetallic materials

Cuts can be started at any location; does not produce heat; produces very little burring

Water Jet Machining

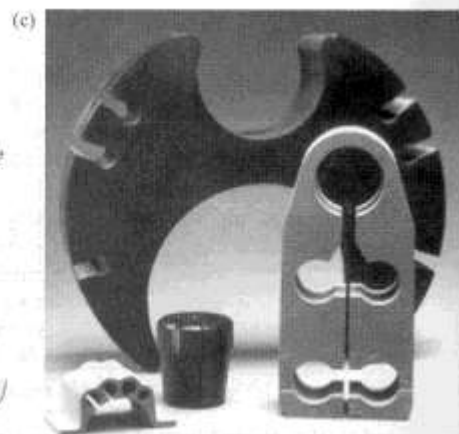
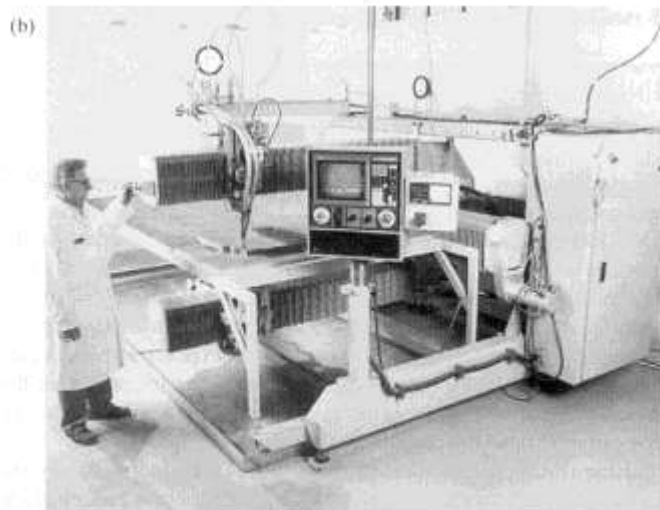
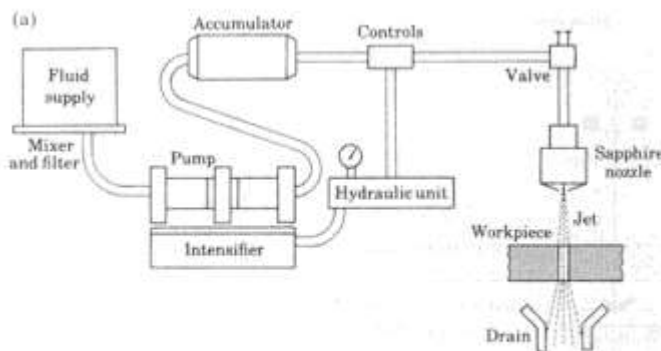

FIGURE 26.16 (a) Schematic illustration of water-jet machining. (b) A computer-controlled, water-jet cutting machine cutting a granite plate. (c) Example of various nonmetallic parts produced by the water-jet cutting process. *Source:* Courtesy of Possis Corporation.

Water Jet Machining



Abrasive Water Jet Machining

The water jet contains abrasive particles; this increases the material removal rate

Can cut metallic, nonmetallic, and advanced composite materials

Suitable for heat-sensitive materials

Abrasive Jet Machining

A high-speed jet of dry air, nitrogen or carbon dioxide carries abrasive particles

Good for cutting hard or brittle materials

Can be used for deburring, cleaning, or removing oxides or surface films

Abrasive Jet Machining

FIGURE 26.17 Schematic illustration of the abrasive-jet machining process.

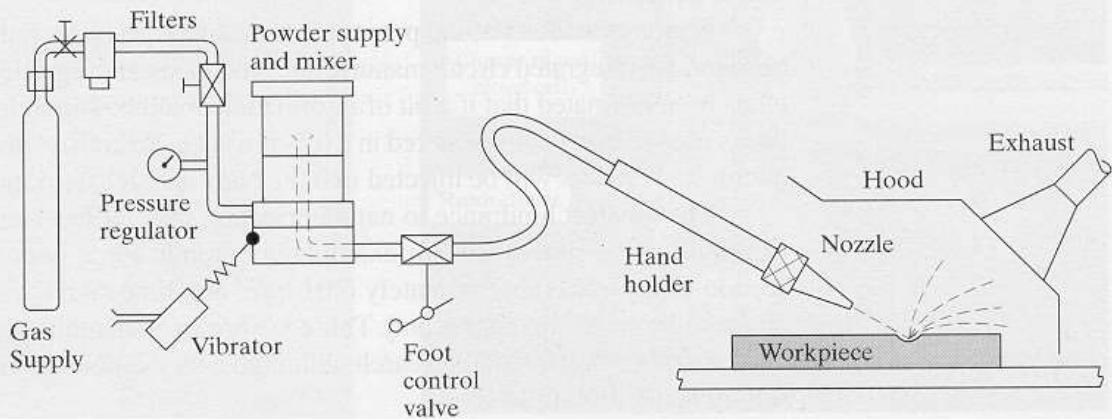

Summary

Advanced machining processes offer alternatives where conventional procedures would be insufficient or uneconomical

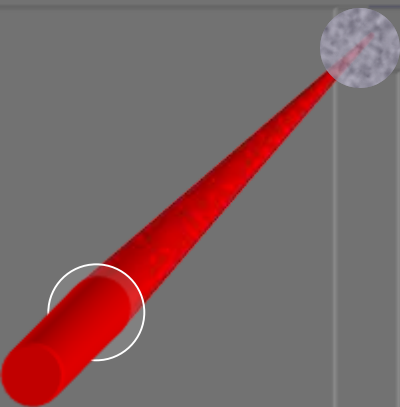

Thankyou

Laser Beam Machining (LBM)

By

Dr. Ufaith Qadiri

Laser Beam Machining – An Introduction

- LASER stands for Light Amplification by Stimulated Emission of Radiation.
- The underline working principle of laser was first put forward by Albert Einstein in 1917 though the first industrial laser for experimentation was developed around 1960s.
- Laser beam can very easily be focused using optical lenses as their wavelength ranges from half micron to around 70 microns.

- Focussed laser beam can have power density in excess of 1 MW/mm².
- Laser Beam Machining or more broadly laser material processing deals with machining and material processing like heat treatment, alloying, cladding, sheet metal bending etc.
- Such processing is carried out utilizing the energy of coherent photons or laser beam, which is mostly converted into thermal energy upon interaction with most of the materials.

- As laser interacts with the material, the energy of the photon is absorbed by the work material leading to rapid substantial rise in local temperature. This in turn results in melting and vaporisation of the work material and finally material removal.
- Nowadays, laser is also finding application in regenerative machining or rapid prototyping as in processes like stereolithography, selective laser sintering etc.

Laser Beam Machining – The Lasing Process

- Lasing process describes the basic operation of laser, i.e. generation of coherent beam of light by “light amplification” using “stimulated emission”.
- In the model of atom, negatively charged electrons rotate around the positively charged nucleus in some specified orbital paths.
- The geometry and radii of such orbital paths depend on a variety of parameters like number of electrons, presence of neighbouring atoms and their electron structure, presence of electromagnetic field etc. Each of the orbital electrons is associated with unique energy levels.

- At absolute zero temperature an atom is considered to be at ground level, when all the electrons occupy their respective lowest potential energy.
- The electrons at ground state can be excited to higher state of energy by absorbing energy from external sources like increase in electronic vibration at elevated temperature, through chemical reaction as well as via absorbing energy of the photon.
- Fig. 1 depicts schematically the absorption of a photon by an electron. The electron moves from a lower energy level to a higher energy level.

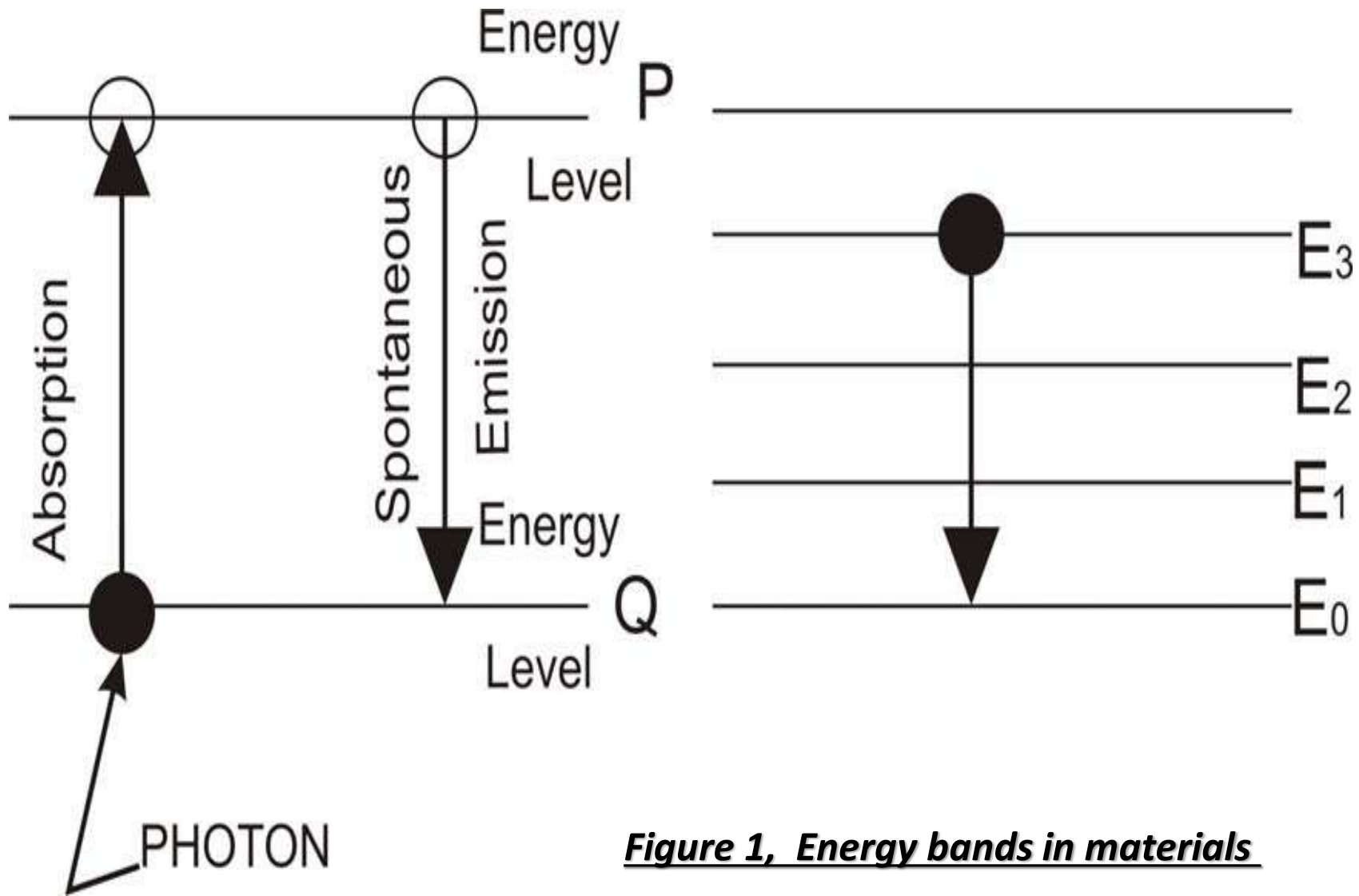

Figure 1, Energy bands in materials

- On reaching the higher energy level, the electron reaches an unstable energy band. And it comes back to its ground state within a very small time by releasing a photon. This is called **spontaneous emission**.
- Schematically the same is shown in Fig. 1 and Fig. 2. The spontaneously emitted photon would have the same frequency as that of the “exciting” photon.

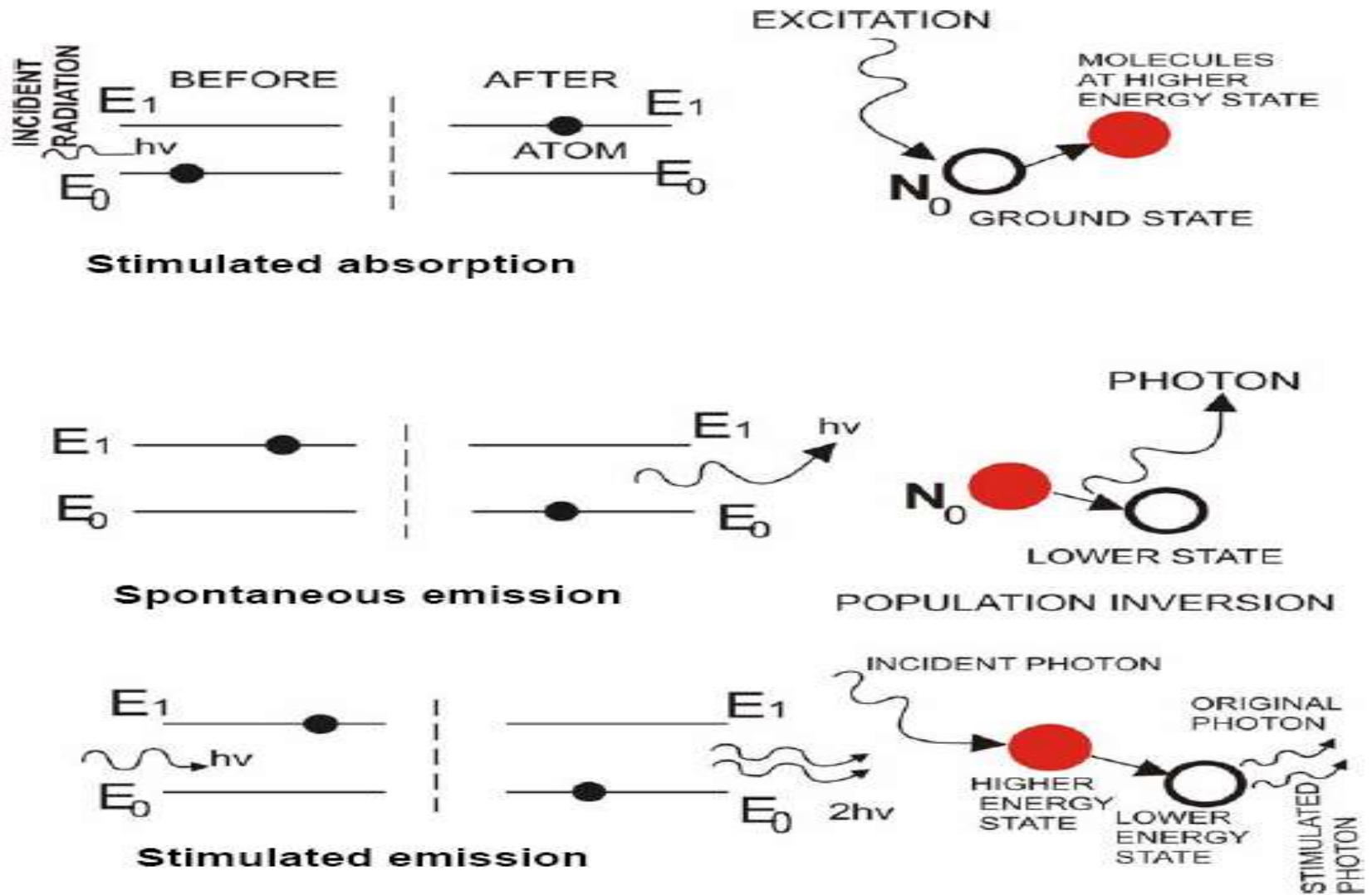

Fig. 2 Spontaneous and Stimulated emissions

- Sometimes such change of energy state puts the electrons in a meta-stable energy band. Instead of coming back to its ground state immediately it stays at the elevated energy state for micro to milliseconds.
- In a material, if more number of electrons can be somehow pumped to the higher meta-stable energy state as compared to number of electrons at ground state, then it is called “population inversion”.
- Such electrons, at higher energy meta-stable state, can return to the ground state in the form of an avalanche provided stimulated by a photon of suitable frequency or energy. This is called **stimulated emission**. Fig.2 shows one such higher state electron in meta-stable orbit.

- If it is stimulated by a photon of suitable energy then the electron will come down to the lower energy state and in turn one original photon will be produced. In this way **coherent laser beam can be produced.**
- Fig. 3 schematically shows working of a laser.

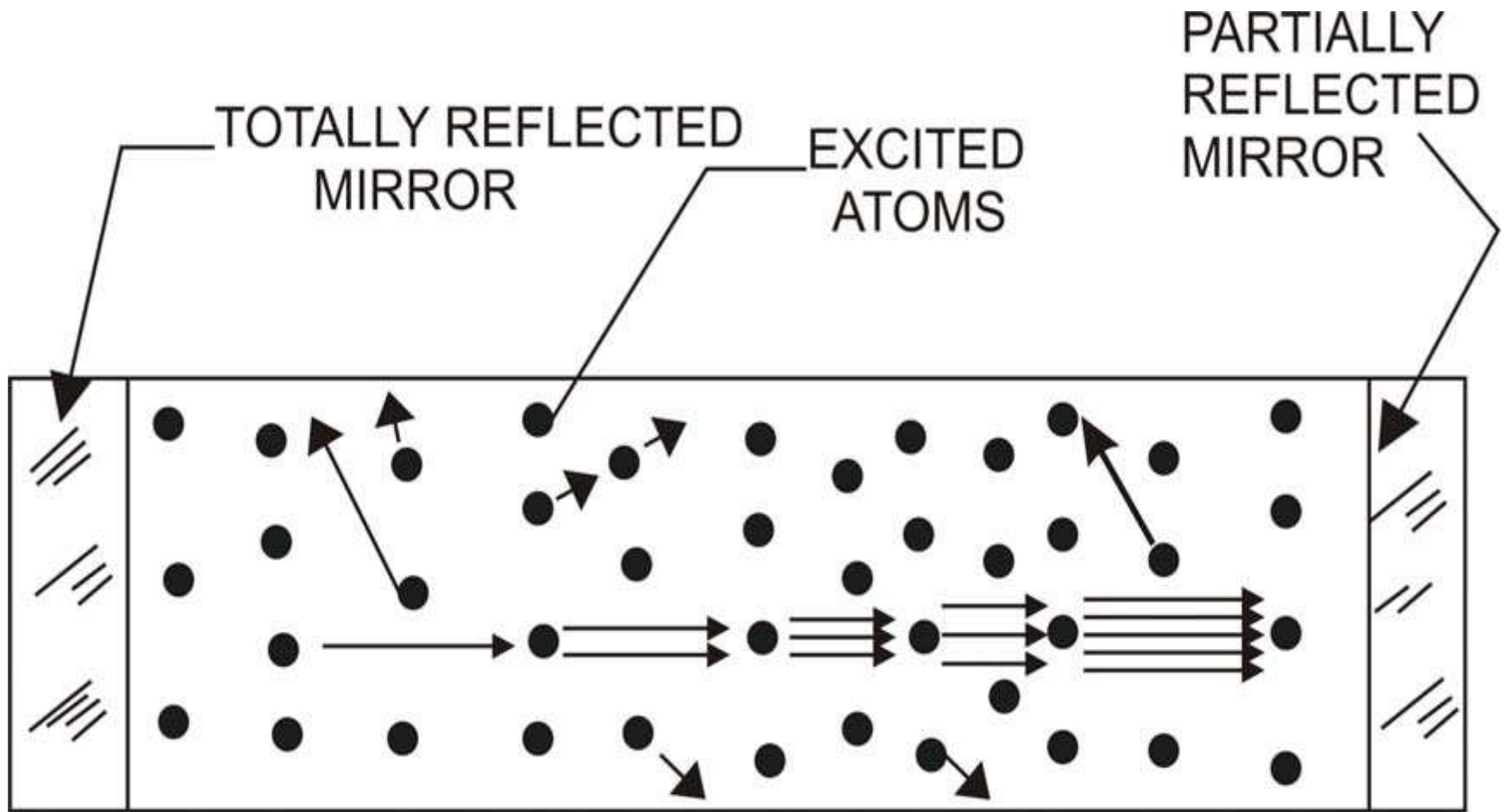

Fig. 3 Lasing Action

- There is a gas in a cylindrical glass vessel. This gas is called the lasing medium.
- One end of the glass is blocked with a 100% reflective mirror and the other end is having a partially reflective mirror. Population inversion can be carried out by exciting the gas atoms or molecules by pumping it with flash lamps.
- Then stimulated emission would initiate lasing action. Stimulated emission of photons could be in all directions.
- Most of the stimulated photons, not along the longitudinal direction would be lost and generate waste heat. The photons in the longitudinal direction would form coherent, highly directional, intense laser beam.

Lasing Medium- Heart Of LASER

- Many materials can be used as the heart of the laser. Depending on the lasing medium lasers are classified as solid state and gas laser.
- Solid-state lasers are commonly of the following type
 - Ruby which is a chromium – alumina alloy having a wavelength of $0.7 \mu\text{m}$
 - Nd-glass lasers having a wavelength of $1.64 \mu\text{m}$.
 - Nd-YAG laser having a wavelength of $1.06 \mu\text{m}$.
(Nd-YAG stands for neodymium-doped yttrium aluminium garnet; $\text{Nd:Y}_3\text{Al}_5\text{O}_{12}$)
- These solid-state lasers are generally used in material processing.

- The generally used gas lasers are:
 - Helium – Neon
 - Argon
 - CO₂ etc.
- Lasers can be operated in continuous mode or pulsed mode. Typically CO₂ gas laser is operated in continuous mode and Nd – YAG laser is operated in pulsed mode.

Schematic diagram of Laser Beam Machine

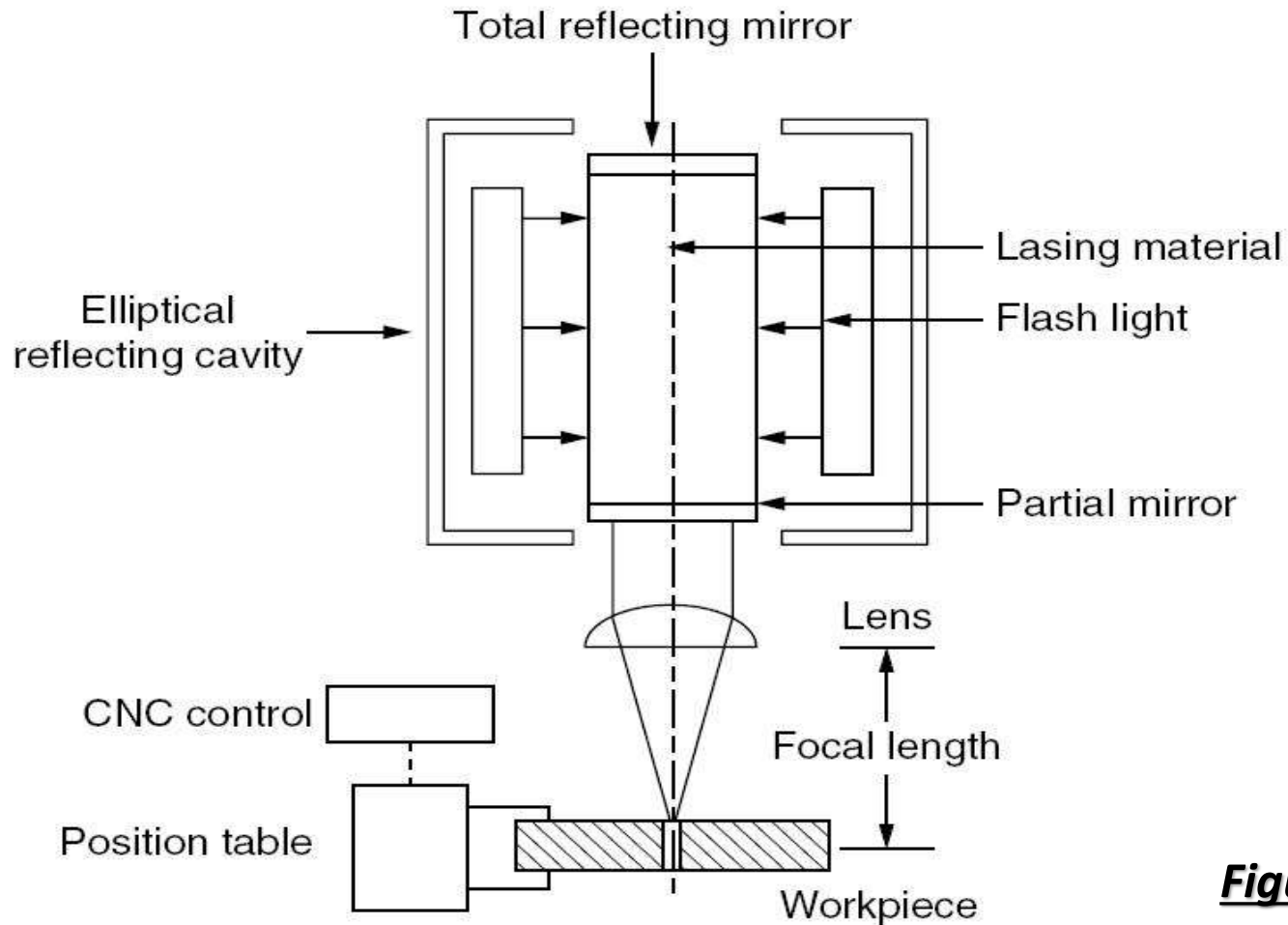
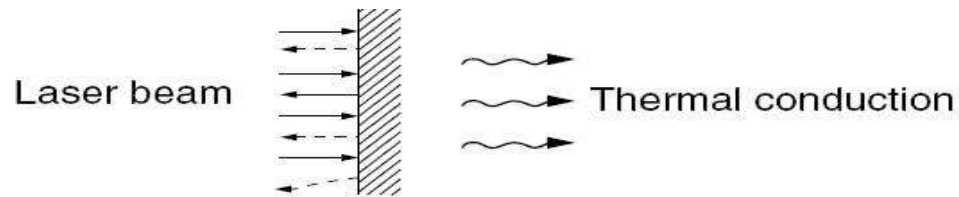
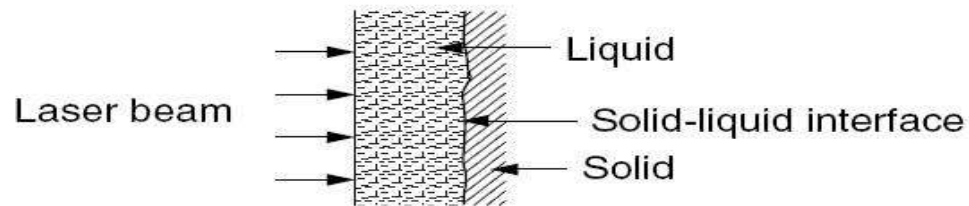

Figure 4

Material Removal Mechanism In LBM



(a) Absorption and heating



(b) Melting

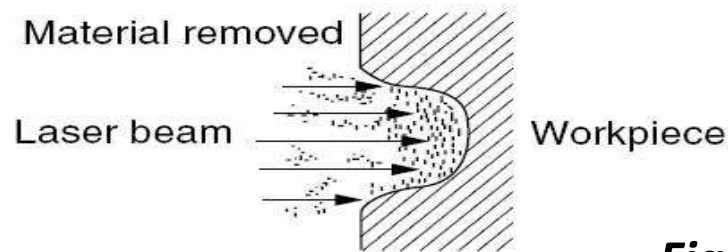

(c) Vaporization

Figure 5 Physical processes occurring during LBM

- As presented in Fig. 5, the unreflected light is absorbed, thus heating the surface of the workpiece.
- On sufficient heat the workpiece starts to melt and evaporates.
- The physics of laser machining is very complex due mainly to scattering and reflection losses at the machined surface. Additionally, heat diffusion into the bulk material causes phase change, melting, and/or vaporization.
- Depending on the power density and time of beam interaction, the mechanism progresses from one of heat absorption and conduction to one of melting and then vaporization.

- Machining by laser occurs when the power density of the beam is greater than what is lost by conduction, convection, and radiation, and moreover, the radiation must penetrate and be absorbed into the material.
- The power density of the laser beam, P_d is given by

$$P_d = \frac{4L_p}{\pi F_l^2 \alpha^2 \Delta T}$$

- The size of the spot diameter d_s is

$$d_s = F_l \alpha$$

- The machining rate ϕ (mm/min) can be described as follows:

$$\phi = \frac{C_l L_p}{E_v A_b h}$$

Where A_b = area of laser beam at focal point, mm^2

$$A_b = \frac{\pi}{4} (F_l \alpha)^2$$

Therefore,

$$\phi = \frac{4C_l L_p}{\pi E_v (F_l \alpha)^2 h}$$

- The volumetric removal rate (VRR) (mm^3/min) can be calculated as follows:

$$\text{VRR} = \frac{C_l L_p}{E_v h}$$

where P_d = power density, W/cm^2

L_p = laser power, W

F_l = focal length of lens, cm

ΔT = pulse duration of laser, s

α = beam divergence, rad

C_l = constant depending on the material and conversion efficiency

E_v = vaporization energy of the material, W/mm^3

A_b = area of laser beam at focal point, mm^2

h = thickness of material, mm

d_s = spot size diameter, mm

LASER Beam Machining – Application

- Laser can be used in wide range of manufacturing applications
 - Material removal – drilling, cutting and tre-panning
 - Welding
 - Cladding
 - Alloying
- Drilling micro-sized holes using laser in difficult – to – machine materials is the most dominant application in industry. In laser drilling the laser beam is focused over the desired spot size. For thin sheets pulse laser can be used. For thicker ones continuous laser may be used.

Parameters Affecting LBM

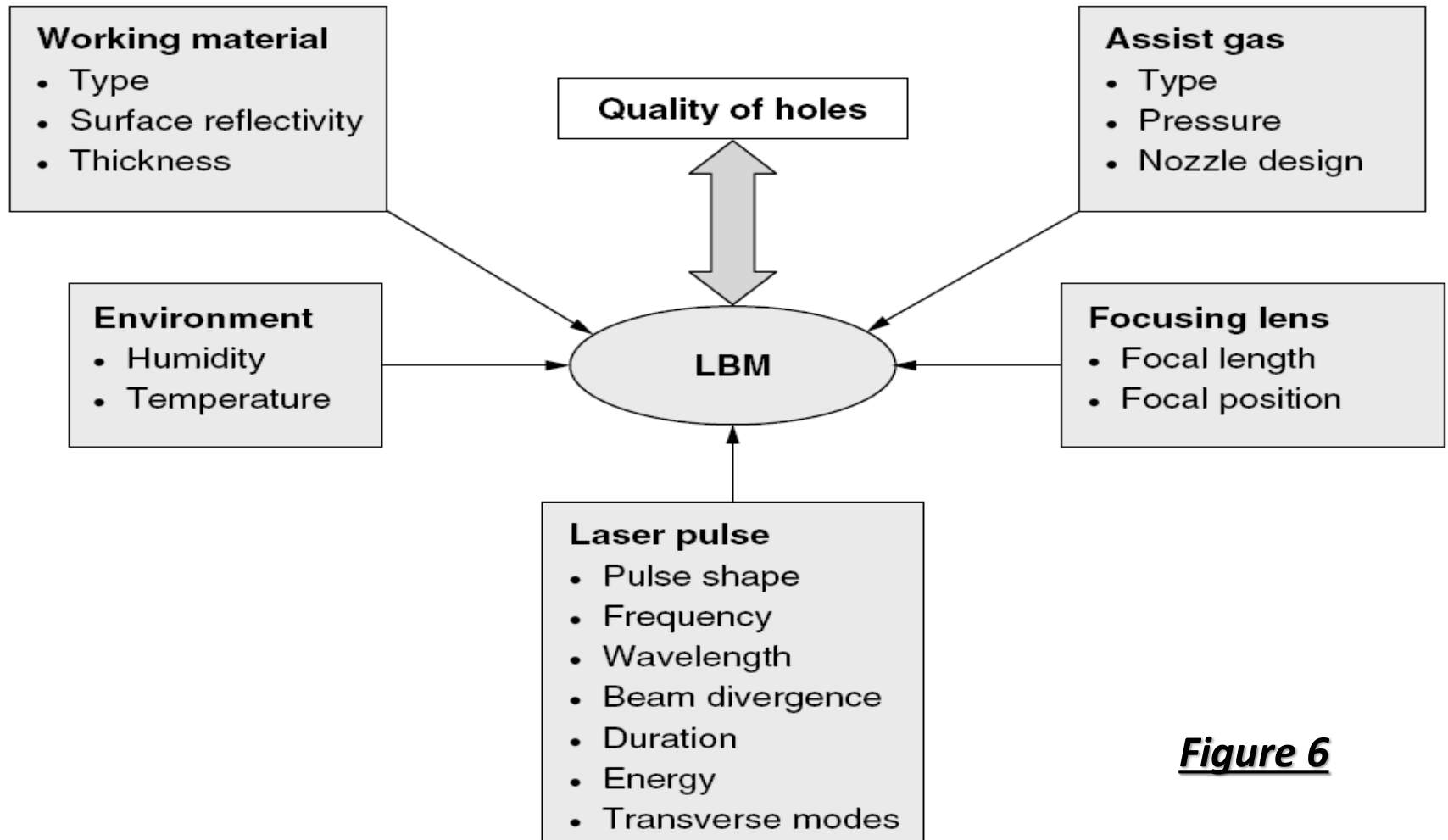

Figure 6

- Fig. 6 presents the factors which affect the LBM process. The factors can be related to LBM Drilling process and are discussed below:
- Pulse Energy: It is recommended that the required peak power should be obtained by increasing the pulse energy while keeping the pulse duration constant. Drilling of holes with longer pulses causes enlargement of the hole entrance.
- Pulse Duration: The range of pulse durations suitable for hole drilling is found to be from 0.1 to 2.5 millisecond. High pulse energy (20J) and short pulse duration are found suitable for deep hole drilling in aerospace materials.

- Assist Gases: The gas jet is normally directed with the laser beam into the interaction region to remove the molten material from the machining region and obtain a clean cut. Assist gases also shield the lens from the expelled material by setting up a high-pressure barrier at the nozzle opening. Pure oxygen causes rapid oxidation and exothermic reactions, causing better process efficiency. The selection of air, oxygen, or an inert gas depends on the workpiece material and thickness.
- Material Properties and Environment: These include the surface characteristics such as reflectivity and absorption coefficient of the bulk material. Additionally, thermal conductivity and diffusivity, density, specific heat, and latent heat are also considered.

Laser Beam Selection Guide

Application		Laser type
Drilling	Small holes, 0.25 mm	Ruby, Nd-Glass, Nd-YAG
	Large holes, 1.52 mm	Ruby, Nd-Glass, Nd-YAG
	Large holes, trepanned	Nd-YAG, CO ₂
	Drilling, percussion	Ruby, Nd-YAG
Cutting	Thick cutting	CO ₂ + gas assistance
	Thin slitting, metals	Nd-YAG
	Thin slitting, plastics	CO ₂
	Plastics	CO ₂
Materials	Metals	Ruby, Nd-Glass, Nd-YAG
	Organics and nonmetals	Pulsed CO ₂
	Ceramics	Pulsed CO ₂ , Nd-YAG

Laser Beam Machining: New Developments

- In 1994 Lau et al., introduced the ultrasonic assisted laser machining technique not only to increase the hole depth but also to improve the quality of holes produced in aluminium-based metal matrix composites (MMC). Using such a method, the hole depth was increased by 20 percent in addition to the reduced degree of hole tapering.
- In 1995 Hsu and Molian, developed a laser machining technique that employs dual gas jets to remove the viscous stage in the molten cutting front and, thereby, allowing stainless steel to be cut faster, cleaner, and thicker.

- In 1997, Todd and Copley developed a prototype laser processing system for shaping advanced ceramic materials. This prototype is a fully automated, five-axis, closed-loop controlled laser shaping system that accurately and cost effectively produces complex shapes in the above-mentioned material.
- **Laser Assisted EDM:** In 1997, Allen and Huang developed a novel combination of machining processes to fabricate small holes. Before the micro-EDM of holes, copper vapour laser radiation was used to obtain an array of small holes first. These holes were then finished by micro-EDM. Their method showed that the machining speed of micro-EDM had been increased and electrode tool wear was markedly reduced while the surface quality remained unchanged.

Laser Beam Machining – Advantages

- Tool wear and breakage are not encountered.
- Holes can be located accurately by using an optical laser system for alignment.
- Very small holes with a large aspect ratio can be produced.
- A wide variety of hard and difficult-to-machine materials can be tackled.
- Machining is extremely rapid and the setup times are economical.
- Holes can be drilled at difficult entrance angles (10° to the surface).
- Because of its flexibility, the process can be automated easily such as the on-the-fly operation for thin gauge material, which requires one shot to produce a hole.
- The operating cost is low.

Laser Beam Machining – Limitations

- High equipment cost.
- Tapers are normally encountered in the direct drilling of holes.
- A blind hole of precise depth is difficult to achieve with a laser.
- The thickness of the material that can be laser drilled is restricted to 50 mm.
- Adherent materials, which are found normally at the exit holes, need to be removed.

References:

- Advanced Machining Processes By Hassan Abdel-Gawad El-Hofy
- Non Conventional Machining By P.K. Mishra



THANK
YOU

The image features the words "THANK YOU" in a bold, blue, 3D sans-serif font. The letters are arranged in two rows: "THANK" on top and "YOU" below it. The text is set against a black rectangular background that is slightly tilted. The 3D effect is achieved through shading and perspective, with the letters appearing to rise from the surface. The word "YOU" is notably larger and more prominent than "THANK".